

Accessories for cable trunking

PLIO® retaining clip

PLIO® bridging clip



PLIO®



PLIO GX-1 GX-2

Material: PP
Colour: grey
Operating temperatures: -25 to +70°C
Flame resistance: V2 UL94
Specifications: halogen free

Application: keeps cable in trunking GN-A6/4 and GF-DIN-A7/5.

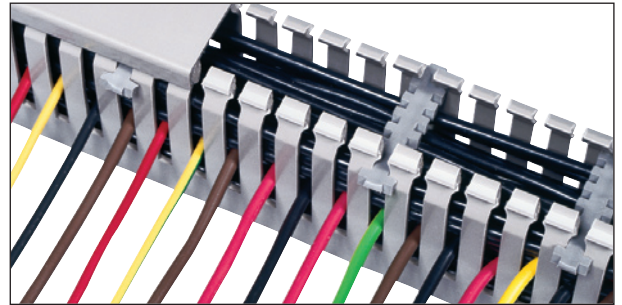

The GX clips have following functions:

- keeping cables secured when trunking is mounted horizontally or vertically.
- ensuring easier lid fixing due to the oblique teeth supporting the trunking webs.
- easy assembly, the clip should be clamped between two webs on the appropriate trunking width.

type	article number	width mm	length mm	thickness mm	for trunking height (mm)	 pces
GX-1 HF	0845 0917 013	9	147	2,5	≤ 75	50
GX-2 HF	0845 0918 013	9	147	2,5	80 - 100	50

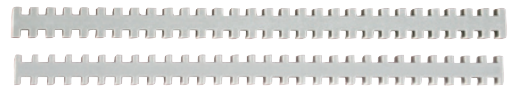

PLIO GX

Material: PA halogen free
Colours: black
Operating temperatures: -40 to +100°C
Flame resistance: V0 UL94
Specification: halogen free

Application: keeps cable in GN-A6/4, GF-DIN-A7/5 and GF-A6/4 trunking.

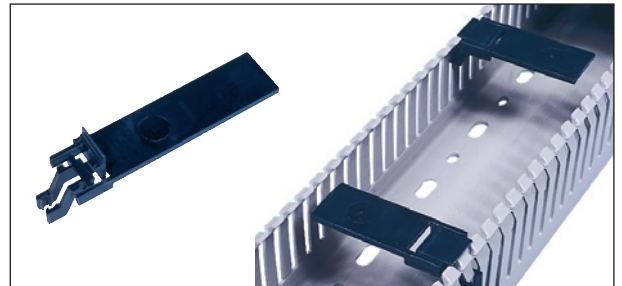

Clips are of universal use, they can be cut to the trunking width.

Allows complete or partial change of cabling at any time without removal of clip.

It is advisable to position clamps every 20/30 cm on the trunking, by alternating the fixing side (see picture).

type	article number	width mm	length mm	for trunking series	for trunking height (mm)	 pces
GX-DIN-A7/5 HF	0845 0916 010	24	108	GF-DIN-A7/5 GF-DIN-SH-A7/5	25 ... 75	50
GX-A6/4 HF	0845 0915 010	22,5	105	GN-A6/4 GN-HF-A6/4	42 ... 80 60	50

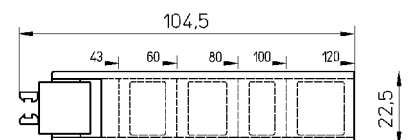
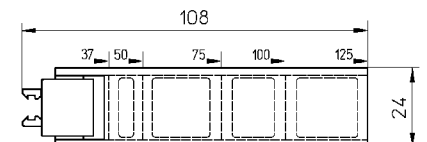

BR-GN

Material: PS
Colour: grey
Operating temperatures: -40 to +70°C
Flame resistance: V2 UL94

Application: keeps cables in GN trunking.
 Thanks to its design, this retaining clip is usable on every GN-A6/4 trunking.

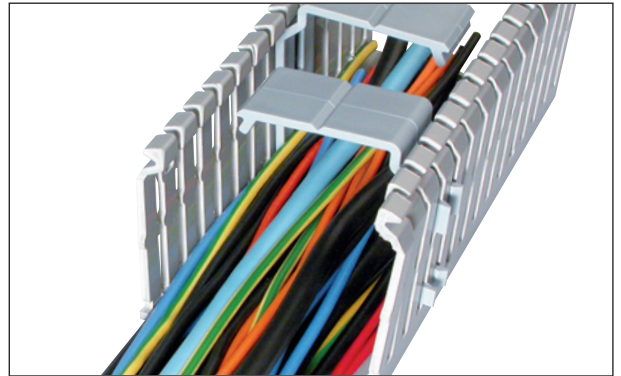

type	article number	pcs
BR-GN	0839 0100 013	50

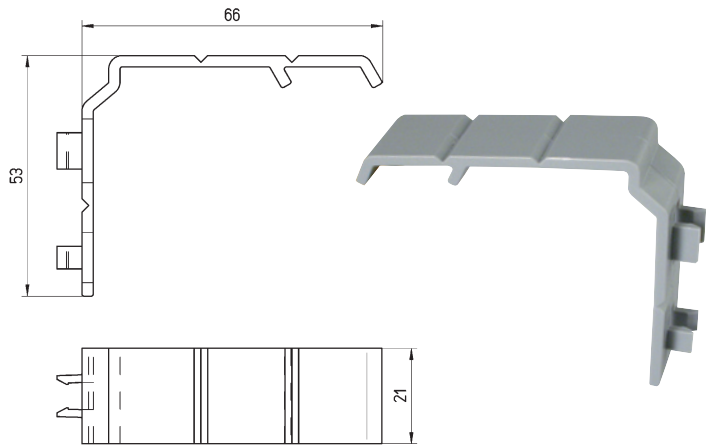
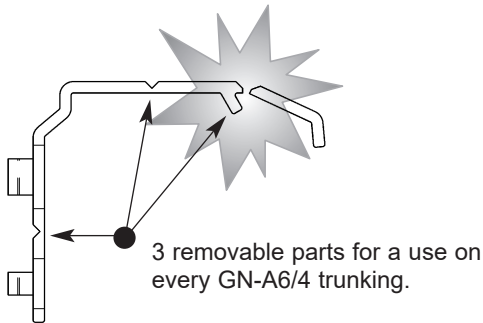

BR-GN-HF

Material: PC/ABS, flame retardant
Colour: light grey
Operating temperatures: -25 to +90°C
Specification: V0 UL94
 halogen free

Application: keeps cables in GN-HF-A6/4 trunking with a width of 30 mm or more and heights of 40, 60 and 80 mm. Easy and quick to use.

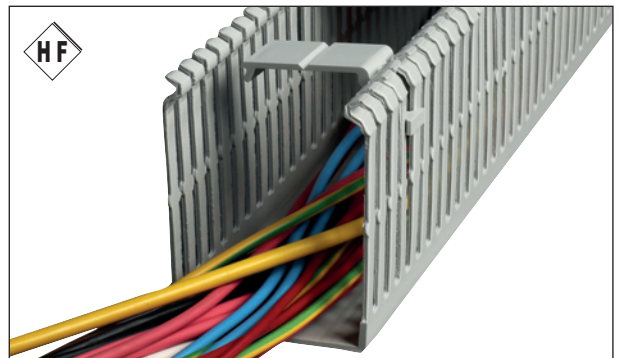

type	article number	pcs
BR-GN-HF	0850 0100 025	50

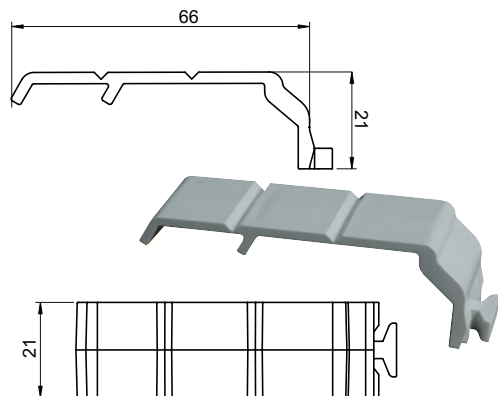
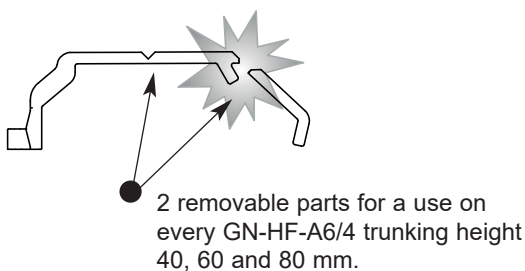



BR-GF-DIN

New

Material: ABS
Colour: grey
Operating temperatures: -40 to +70°C
Flame resistance: V0 UL94

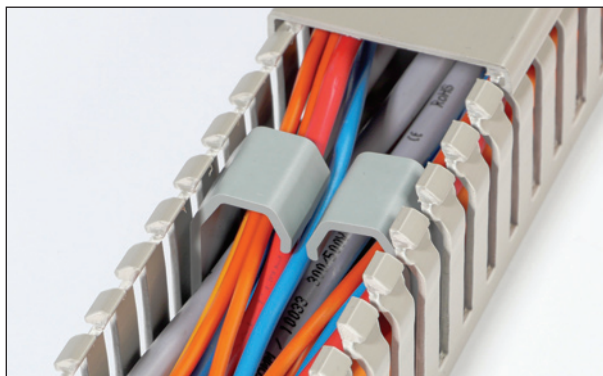
Application: to hold cables in place when they are installed in GF-DIN type trunking. They can be used with slotted or solid trunking. Flanges are supplied as standard with adhesive tape on the bottom for quick, permanent installation.



type	article number	for trunking	H mm	L mm	I mm	 pces
BR-GF-DIN 50x50	0845 0930 013	GF-DIN-A7/5 50x50 GF-DIN-S 50x50	41,5	43	20	50
BR-GF-DIN 50x75	0845 0931 013	GF-DIN-A7/5 50x75 GF-DIN-S 50x75	41,5	68	20	50
BR-GF-DIN 50x125	0845 0932 013	GF-DIN-A7/5 50x125 GF-DIN-S 50x125	41,5	117	20	50
BR-GF-DIN 75x50	0845 0933 013	GF-DIN-A7/5 75x50 GF-DIN-S 75x50	66,5	43	20	50
BR-GF-DIN 75x75	0845 0934 013	GF-DIN-A7/5 75x75 GF-DIN-S 75x75	66,5	68	20	50
BR-GF-DIN 75x125	0845 0935 013	GF-DIN-A7/5 75x125 GF-DIN-S 75x125	66,5	117	20	50

