

## DG-TPE

<b>Material:</b>	TPE type PP/EPDM
<b>Colours:</b>	black - light grey
<b>Operating temperatures:</b>	-50 to +125°C
<b>Tensile strength at break:</b>	> 4,5 MPa
<b>Ultimate elongation:</b>	> 300 %
<b>Dielectric strength:</b>	35 kV/mm
<b>Flame resistance:</b>	HB UL94 (internal test)
<b>Specification:</b>	halogen free

**Applications:** grommets with membrane allowing closure of unused entries. They ensure a semi-sealing against dust when cables or conduits pass through their membrane.



## • Membrane grommets

type	article number		dimensions (mm)								pcs
	black 010	grey 025	Ø A	Ø B	Ø C1	Ø C2	E	F1	F2	M	
DG-TPE 9	0144 0010 010	0144 0010 025	9	15	20	18	2	2,5	2,5	1	100
DG-TPE 11	0144 0020 010	0144 0020 025	11	18	22,5	21,5	2	2,5	2,5	1	100
DG-TPE 13,5	0144 0030 010	0144 0030 025	13,5	20	24	24	2	2,5	2,5	1	100
DG-TPE 16	0144 0040 010	0144 0040 025	16	22	27,5	26	2	2,7	2,7	1	100
DG-TPE 21	0144 0050 010	0144 0050 025	21	28	34,5	34,5	2	3	3	1	100
DG-TPE 21/E1	0144 0051 010	-	21	28	34,5	34,5	1	4	3	1,2	100
DG-TPE 29	0144 0060 010	-	29	37	43,5	43,5	2,2	3,7	3,7	1,3	50
DG-TPE 36	0144 0070 010	-	35,5	47	52,5	52,5	2,5	3,8	3,8	1,3	50
DG-TPE 48	0144 0080 010	-	47	59	67	67	2,5	4	4	1,5	50
DG-TPE M20	0144 0401 010	0144 0401 025	13,5	20	24	24	2	2,5	2,5	1	100
DG-TPE M25	0144 0402 010	0144 0402 025	21	25	34,5	31,5	2	3	3	1	100
DG-TPE M32	0144 0403 010	0144 0403 025	29	32	43,5	39	2,2	3,7	3,7	1,3	100

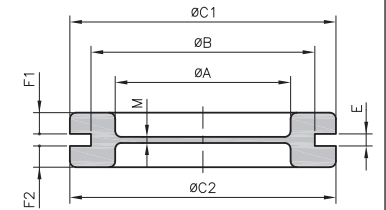

## • Cross-cut membrane grommets (other cuts upon request)

type	article number black 010	dimensions (mm)								pcs	
		Ø A	Ø B	Ø C1	Ø C2	E	F1	F2	M		X
DGC-TPE 9	0144 0211 010	9	15	20	18	2	2,5	2,5	1	8	100
DGC-TPE 11	0144 0221 010	11	18	22,5	21,5	2	2,5	2,5	1	10	100
DGC-TPE 13,5	0144 0231 010	13,5	20	24	24	2	2,5	2,5	1	10	100
DGC-TPE 16	0144 0241 010	16	22	27,5	26	2	2,7	2,7	1	14	100
DGC-TPE 21	0144 0253 010	21	28	34,5	34,5	2	3	3	1	17	100
DGC-TPE 21/E1	0144 0310 010	21	28	34,5	34,5	1	4	3	1,2	19,5	100
DGC-TPE 29	0144 0262 010	29	37	43,5	43,5	2,2	3,7	3,7	1,3	25	50
DGC-TPE 36	0144 0290 010	35,5	47	52,5	52,5	2,5	3,8	3,8	1,3	32	50
DGC-TPE 48	0144 0301 010	47	59	67	67	2,5	4	4	1,5	42	50

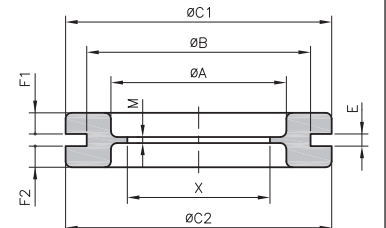
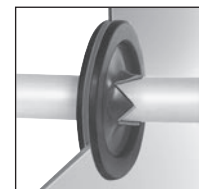

• Grommets with perforated membrane (other cuts upon request)

type	article number	dimensions (mm)								pieces
	black	Ø A	Ø B	Ø C1	Ø C2	E	F	M	Ø P	
	010									
DG-TPE 11/4,5	0144 0220 010	11	18	22,5	21,5	2	2,5	1	4,5	100
DG-TPE 16/10	0144 0240 010	16	22	27,5	26	2	2,7	1	10	100
DG-TPE 21/18	0144 0250 010	21	28	34,5	34,5	2	3	1	18	100
DG-TPE 21/20	0144 0251 010	21	28	34,5	34,5	2	3	1	20	100

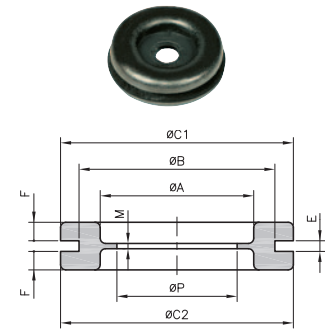

• Special membrane grommets

type	article number	dimensions (mm)							pieces
	black	Ø A	B	C1	C2	D	E	M	
	010								
DG-TPE 12-747	0146 0320 010	13,5	20	24	24	9	4	1	100
DG-TPE 12-1475	0146 0321 010	13,5	20	24	24	9	2	1	100

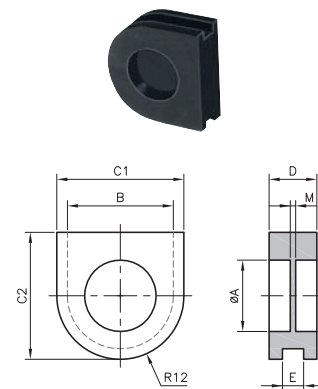

### DGX-TPE

**Material:** TPE  
**Colour:** black - light grey  
**Operating temperature:** -50 to + 125°C  
**Protection:** IP 67  
**Specification:** halogen free

**Applications:** sealing grommet is very flexible, simple and quick to assemble without tools, even on curved surfaces. It adapts to the cable diameter and ensures its protection. It can be used as a stopper.

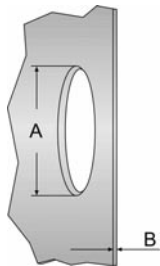
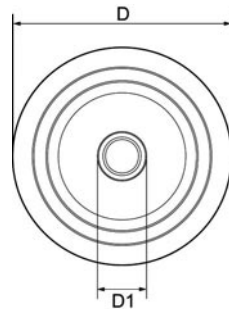
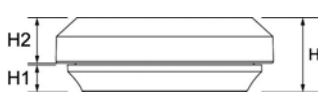

art. no.

black  
010

light grey  
025

for cable Ø  
mm

A  
mm

B  
mm

D\*  
mm

D1  
mm

H  
mm

H1  
mm

H2\*  
mm

 pces

### • Serie DGX metric

type	black 010	light grey 025	for cable Ø mm	A mm	B mm	D* mm	D1 mm	H mm	H1 mm	H2* mm	 pces
DGX-M16-TPE	0144 0701 010	0144 0701 025	5 - 10	16,5	0,5 - 3	23,5	4	11	4	6,75	50
DGX-M20-TPE	0144 0702 010	0144 0702 025	6 - 13	20,5	0,5 - 3	27,5	5	11	4	6,75	50
DGX-M25-TPE	0144 0703 010	0144 0703 025	8 - 17	25,5	0,5 - 3,5	32,5	7	11	4	6,75	50
DGX-M32-TPE	0144 0704 010	0144 0704 025	12 - 24	32,5	0,5 - 4,5	39,5	11	11	4	6,75	25
DGX-M40-TPE	0144 0705 010	0144 0705 025	19 - 31	40,5	1,5 - 4,5	47,5	18	13,5	4,84	7,41	25

### • Serie DGX PG

type	black 010	light grey 025	for cable Ø mm	A mm	B mm	D* mm	D1 mm	H mm	H1 mm	H2* mm	 pces
DGX-PG9-TPE	0144 0711 010	0144 0711 025	5 - 10	16	0,5 - 3	24	4	11	4	6,75	50
DGX-PG11-TPE	0144 0712 010	0144 0712 025	6 - 12	19	0,5 - 3	26	5	11	4	6,75	50
DGX-PG16-TPE	0144 0713 010	0144 0713 025	8 - 15	23	0,5 - 3,5	30	7	11	4	6,75	50
DGX-PG21-TPE	0144 0714 010	0144 0714 025	10 - 20	29	0,5 - 4,5	36	9	11	4	6,75	25
DGX-PG29-TPE	0144 0715 010	0144 0715 025	18 - 27	38	1,5 - 4,5	45	17	13,5	4,84	7,41	25

\* variable according to the wall thickness

### Assembly principle

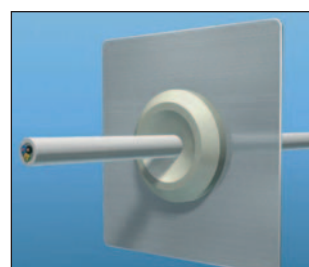
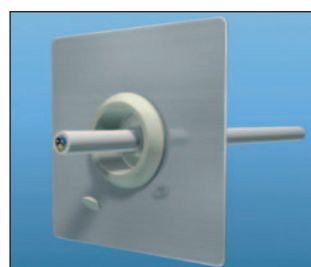
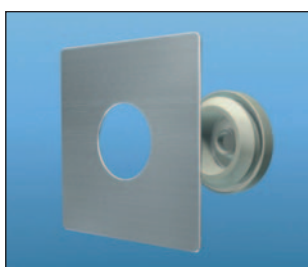



## DGX-MULTI TPE

**Material:** TPE  
**Colour:** black - light grey  
**Operating temperature:** -50 to + 125°C  
**Protection:** IP 67

**Applications:** sealing grommet is very flexible, simple and quick to assemble without tools. Allow the passage of 4 cables while maintaining the seal. It adapts to the cable diameters and protects them. It can be used as a stopper.

**Flame resistance V0 UL94 on request for 3-hole models.**

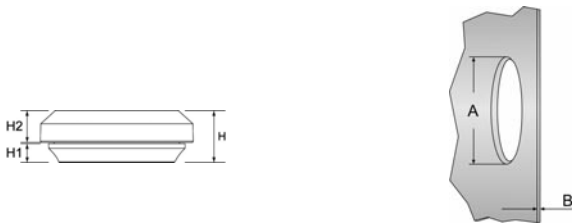

type	art. no.		for cable Ø mm	A mm	B mm	D* mm	D1 mm	H mm	H1 mm	H2* mm	pces
	black 010	light grey 025									

### • Serie DGX-MULTI metric - 3 holes

DGX-MULTI M20-TPE	0144 0722 010	0144 0722 025	3x 4 - 7	20,5	0,5 - 3	27,5	3	11	4	6,75	50
DGX-MULTI M25-TPE	0144 0723 010	0144 0723 025	3x 4 - 9	25,5	0,5 - 3,5	32,5	3	11	4	6,75	50

### • Serie DGX-MULTI PG - 3 holes

DGX-MULTI PG11-TPE	0144 0732 010	0144 0732 025	3x 4 - 6	19	0,5 - 3	26	3	11	4	6,75	50
DGX-MULTI PG16-TPE	0144 0733 010	0144 0733 025	3x 4 - 8	23	0,5 - 3,5	30	3	11	4	6,75	50

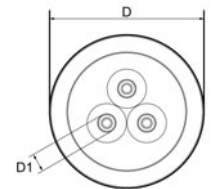

### • Szrie DGX-MULTI metric - 4 holes

DGX-MULTI M25-TPE	0144 0724 010	0144 0724 025	4x3,3-7,3	25,5	1 - 3,5	32,5	3	11	4	6,75	50
-------------------	---------------	---------------	-----------	------	---------	------	---	----	---	------	----

New

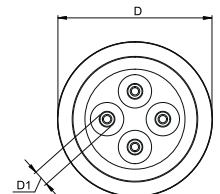

\* variable according to the wall thickness

### Assembly principle

