



Controller with Operator Interface
FT1J/FT2J



SmartAXIS

The All-in-One Solution for Seamless Automation



IDEC CORPORATION

Compact All-in-One PLC + HMI

Extensive connection interfaces with built-in analog inputs/outputs

FT1J

Maximum I/O points: **22** points (analog and digital total)

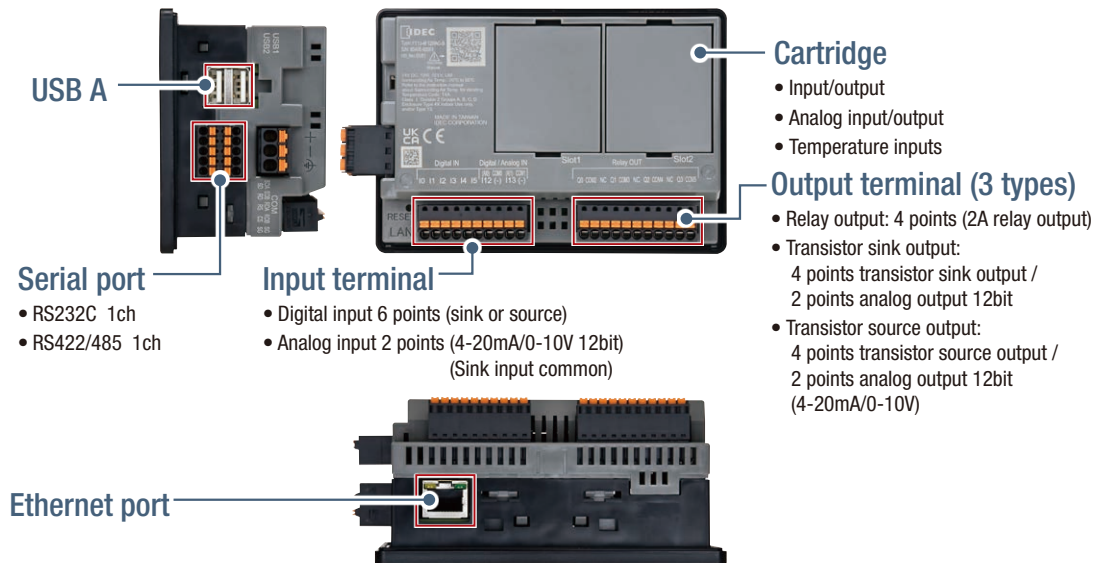

FT2J

Maximum I/O points: **30** points (analog and digital total)

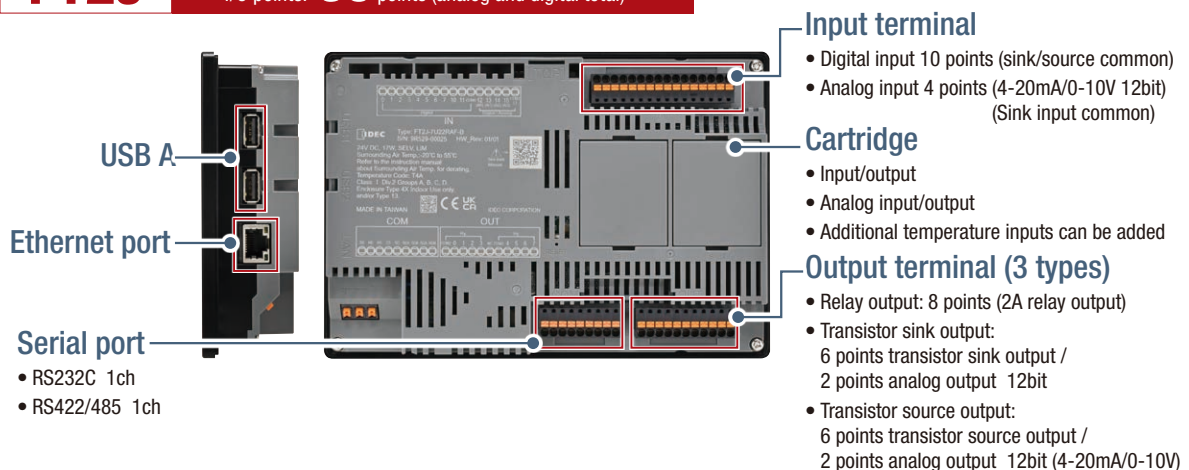

Wide range of control functions

Space-saving compact design

The controller and display are integrated to save space, taking up as little as half the depth of a PLC and HMI combined for the FT1J and one-third for the FT2J. Both models are ideal, especially in areas where space is limited.

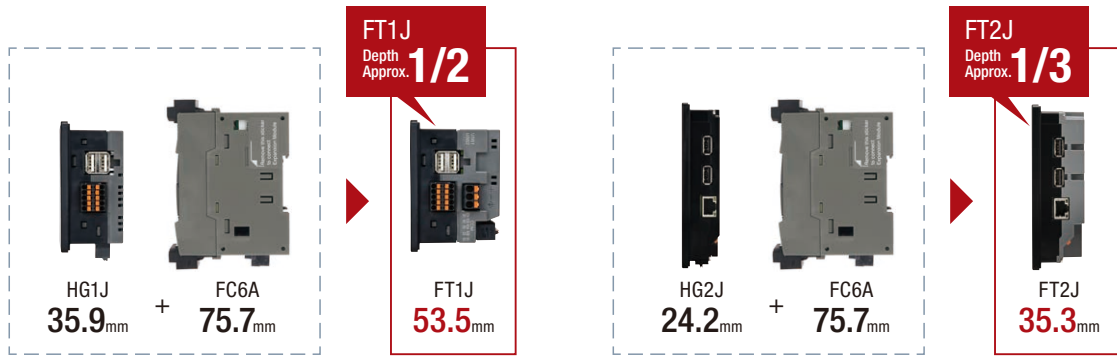

The slim bezel design maximizes your screen viewing experience



Time-saving and easy wiring

Push-in terminal blocks allow for tool-free wiring and provide greater vibration resistance. The detachable terminal block enables separate wiring, improving efficiency.



Environmentally-friendly

The FT2J consumes approximately 40% less power than PLC and display combined.* It also features a battery-free design, eliminating the need for disposable lithium batteries.



*Compared to using FC6A-C24R4CE and HG2J-7UT22TF-B (equivalent products).

Wide range of control functions

Dual CPU configuration for high-speed processing

The FT1J and FT2J have two CPUs working in parallel, unlike conventional products that use a single CPU for both HMI and control functions. This design enables high-speed, real-time control without compromising HMI functionality, broadening the range of compatible applications.

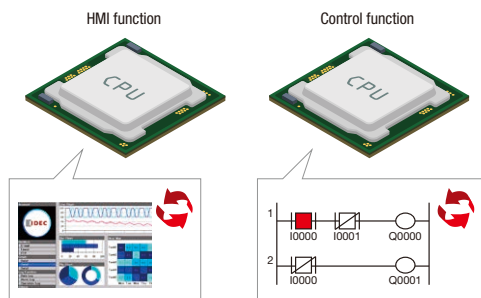

Expansion cartridge with flexible I/O expandability

Up to 2 digital I/O cartridges or analog I/O cartridges can be connected to add up to 8 digital I/O, or up to 4 analog I/O. This makes it easy to add inputs/outputs when connected devices need to be replaced or updated.

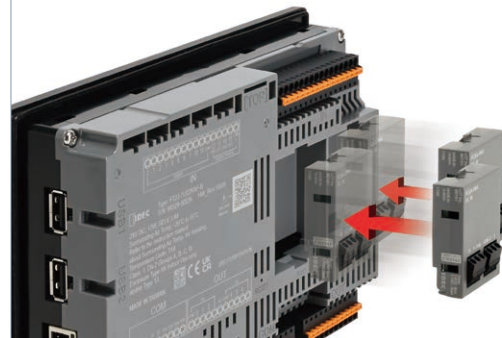

Analog I/O and high-speed counter

12-bit resolution with built-in analog I/O to control analog signals from 0 to 10V DC / 4 to 20mA. (Analog output is available only with the transistor output model.) Connecting an analog potentiometer to the analog input makes it easy to configure analog settings, such as a timer. With the high speed counter input, it can be used in combination with a rotary encoder to control tracking,



Battery-free design eliminates the need for battery replacement

General data is stored in Non-volatile memory, and clock data uses a hyper capacitor, that does not require batteries. No batteries also means no need to fill out extra paperwork to ship controllers internationally.

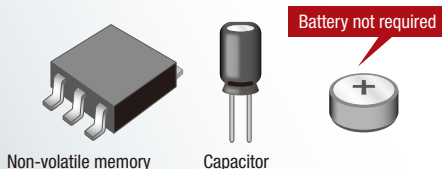

PID control

A PID algorithm with cascade control is available for applications that require temperature, flow, or pressure control.

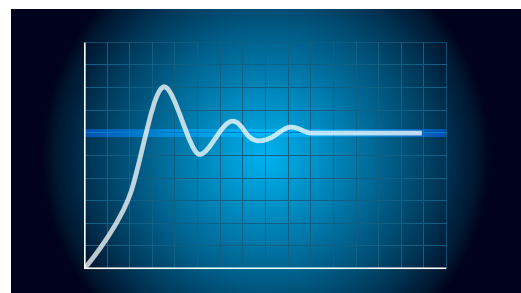

Excellent environmental resistance

Multi-touch touchscreen designed to resist mechanical deterioration

Conventional analog resistive touchscreens are not so well protected against mechanical deterioration. This is because the transparent conductive electrodes and film move with each press of the panel. The PCAP touchscreen uses a sensor board to detect changes in electrical charge to identify where the touchscreen was pressed. As the surface is made of tempered glass, there are no moving parts, allowing for lighter and more agile operations without deterioration. The PCAP touchscreen also prevents unintended activation by water droplets, and can be used while wearing rubber gloves or gloves less than 1.5mm thick¹.

1. The touchscreen may not work with gloves thicker than 1.5mm, depending on the material of the gloves and the environment

PCAP touchscreen

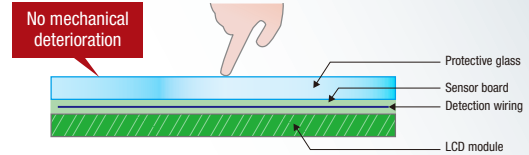

Analog resistive touchscreen

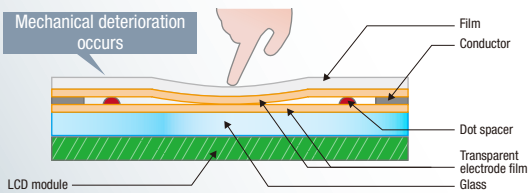

Retains its beauty for years

Conventional products with a plastic film on the surface will cloud over time, reducing visibility due to prolonged UV light exposure. In contrast, the FT1J and FT2J has a glass top that maintains high visibility and prevents deterioration and clouding from long-term UV exposure².

2. If the product is used in a location where it may be exposed to UV rays for a long period. (e.g., near a window), apply a UV protective film to prevent degradation of non-glass parts.



Wide range of operating temperatures

Suitable for use in hot and cold environments ranging from -20 to +55°C³.



3. No freezing.

High water resistance

IP66F / IP67F protection.
Resistant to direct water jets.



Enabling seamless communication



Gateway between manufacturing sites and cloud

Open protocols including EtherNet/IP and Modbus TCP are supported - as are communication protocols with PLCs from different manufacturers. Your FT1J or FT2J device acts as a gateway between your manufacturing site and the cloud. Reading data from other devices and forwarding it to cloud storage with MQTT communication is simple.

MQTT communication

- Supports MQTT communication, ideal for IoT applications.
- Direct connection to the server without a gateway.
- Supports authentication by certificate in addition to ID and password.

EtherNet/IP™



- Supports EtherNet/IP communication.
- Communication with both scanner and adapter devices.

Extensive connectivity with various devices

Extensive communication interfaces

Communication interfaces such as RS232C, RS422/485, Ethernet, and USB-A ports enable easy connection to various external devices.

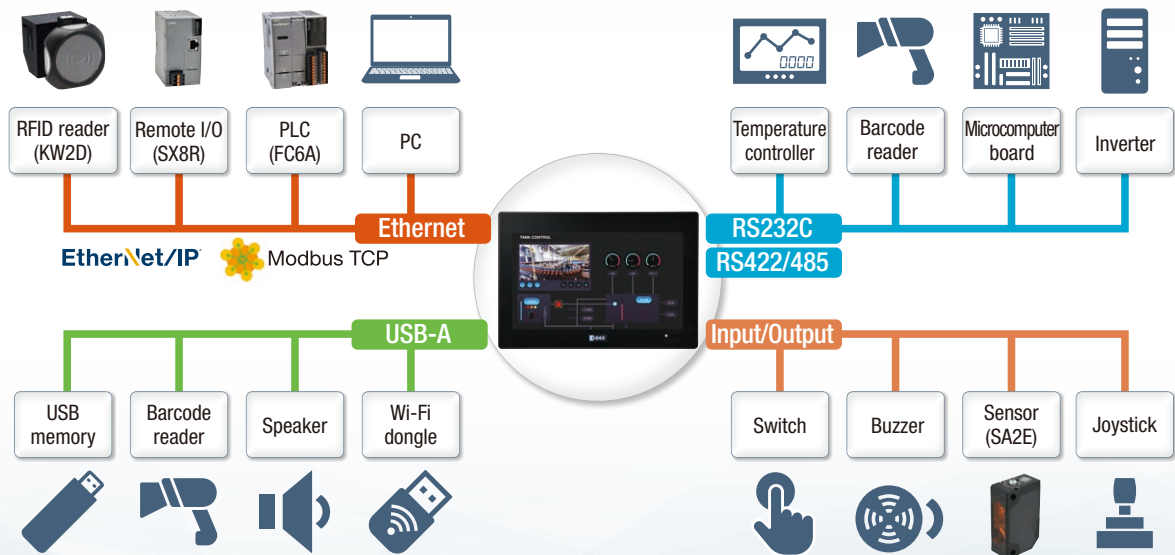

IoT-compatible

A wide range of IoT functionalities enable seamless integration of devices.



1. Subject to change due to specification and service updates.

OI and ladder programming in a single software

Application Software



• Available in Automation Organizer software.

Simultaneous view of OI and ladder programs

Centralized management of tag data and ladder programs with tag editor

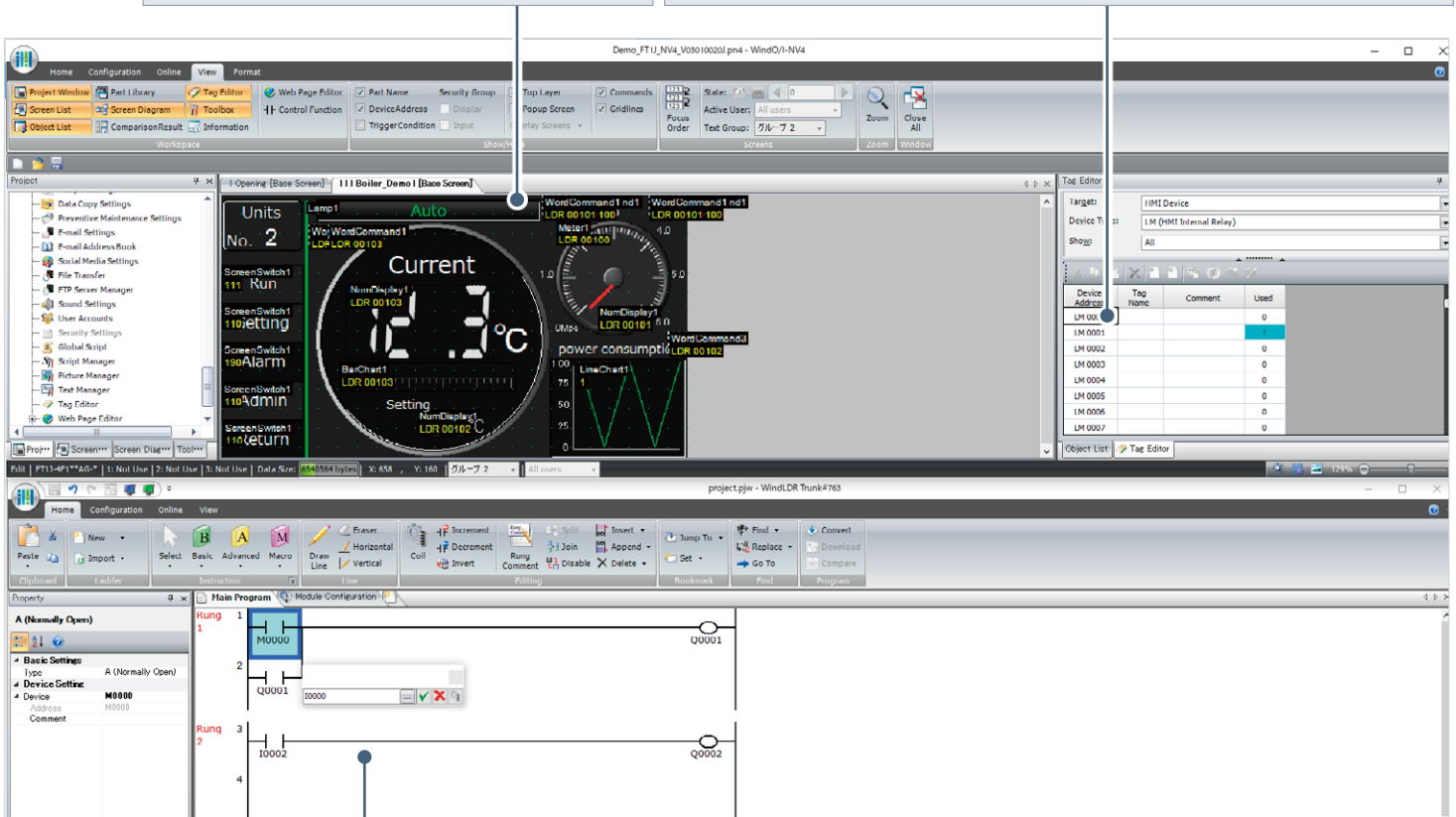

The values for each device can be changed without opening the dialog box. Common keyboard shortcuts (copy, paste, etc.) are supported, saving you even more time.

Script function enables easy programming of complex processes

The script function enables easy programming of complicated processing, such as conditional branching, logical and arithmetic operations, and functions. The script debug function lets you debug your script step-by-step during simulation mode.

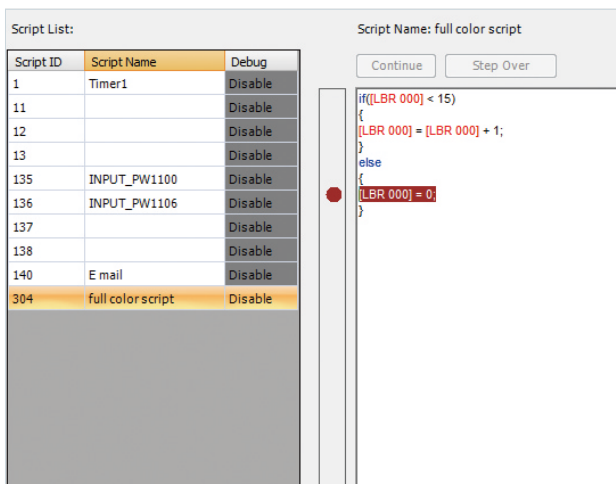

OI and ladder programming are linked even during simulations

The design and ladder programming are linked during simulations. You can confirm the full operation of your program without the actual device.

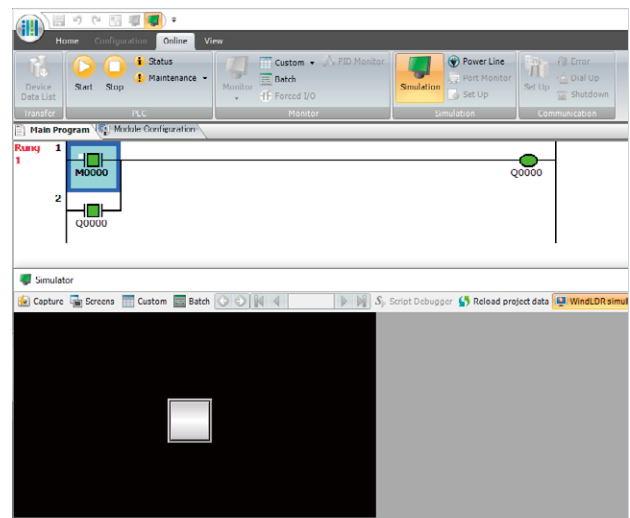

Applications

Food Machinery Streamlined systems improve hygiene levels

Food machinery uses built-in PID control functionality to regulate heat and fluid levels. By incorporating this PID control into the FT1J and FT2J instead of using a temperature controller, less equipment is needed to control the system. Both devices have strong durability, to withstand cleaning with high-powered water jets. Their glass tops can be wiped with alcohol or disinfectant, are sealed against moisture, oil and dirt, and are scratch resistant.

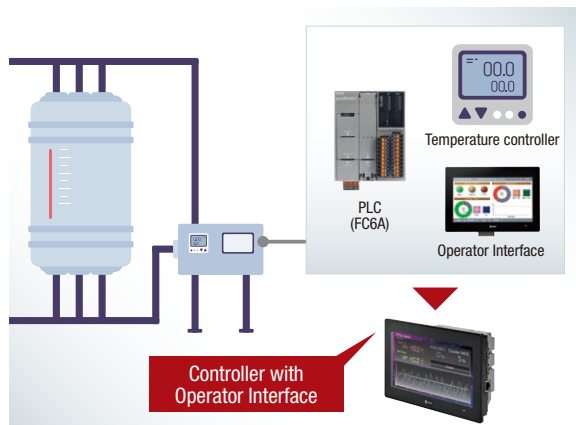

Tempered glass

Stronger than standard glass, the glass touch panel passed a drop test with a 1kg steel ball (dropped onto the center of the glass from a height of 60cm).

Note: Results are from in-house testing and do not guarantee the performance of the product.
Protective sheets (accessory) are also available to prevent glass scattering in case of breakage.

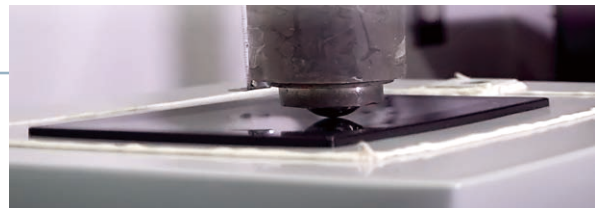

Water treatment Analog and digital I/Os facilitate system automation

Connect I/O devices for monitoring and control, set required values with the touch panel, and your automated system is ready to go. The IoT-related functions can also reduce the need to visit on-site - a real benefit in terms of time and efficiency.

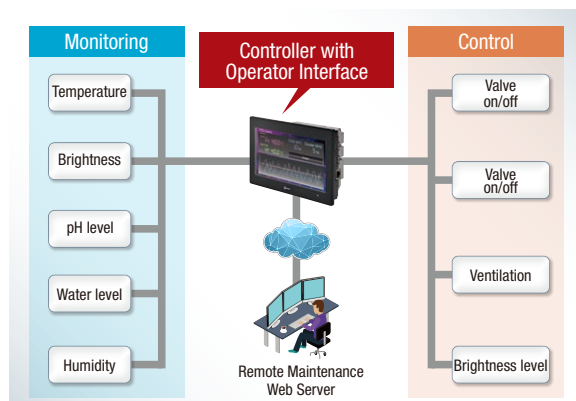

FT1J Controller with Operator Interface

4.3-inch wide

Even more compact and convenient - the all-in-one controller solution

Brightness 500 cd/m ²	TFT 16,770,000 colors	LED 50,000 hours	32-level Brightness Adjustment
Real Parts	Outlined Font	WVGA 480×272	Serial Interface
Ethernet	USB A 2 ports	USB Memory	User Memory 24Mib, 96KB
Front Panel Maintenance	Operating Voltage 24V DC	Operating Temperature -20~+55°C	Portrait

Bezel color



(main unit only)

No.	Name
(1)	POWER LED
(2)	Display
(3)	Touchscreen
(4)	Serial interface (COM)
(5)	USB interface (USB1)
(6)	USB interface (USB2)
(7)	Ethernet interface (LAN)
(8)	Power supply terminal
(9)	Reset switch
(10)	Input terminal (IN)
(11)	Output terminal (OUT)
(12)	Cartridge slot (Slot 1)
(13)	Cartridge slot (Slot 2)

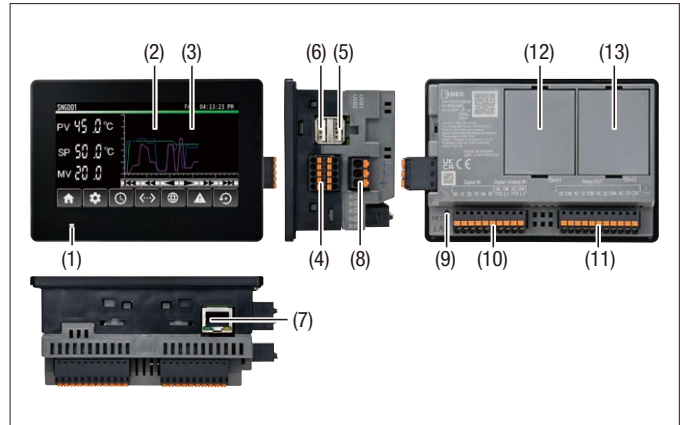

FT1J

Quantity: 1

Display screen	Operation style	Communication interface	Bezel color	Approvals	Input specifications		Output	Part No.
					Digital input	Analog input		
4.3-inch wide TFT color LCD 16,770,000 colors	PCAP touchscreen (Projected capacitive)	Serial interface (RS232C, RS422/485), Ethernet, USB	Black	UL 61010-1 UL 61010-2-201 UL 121201 CSA C22.2 No.61010-1-12 CSA C22.2 No.61010-2-201 CSA C22.2 No.213	6 point (sink)	2 point	4 point 2A relay output	FT1J-4F12RAG-B
					6 point (source)		4 point transistor sink output 2 point analog output	FT1J-4F14KAG-B
					6 point (sink)		4 point transistor source output 2 point analog output	FT1J-4F14SAG-B
			6 point (sink)		4 point 2A relay output		FT1J-4F12RAG-S	
			6 point (source)		4 point transistor sink output 2 point analog output		FT1J-4F14KAG-S	
			6 point (sink)		4 point transistor source output 2 point analog output		FT1J-4F14SAG-S	

Dimensions

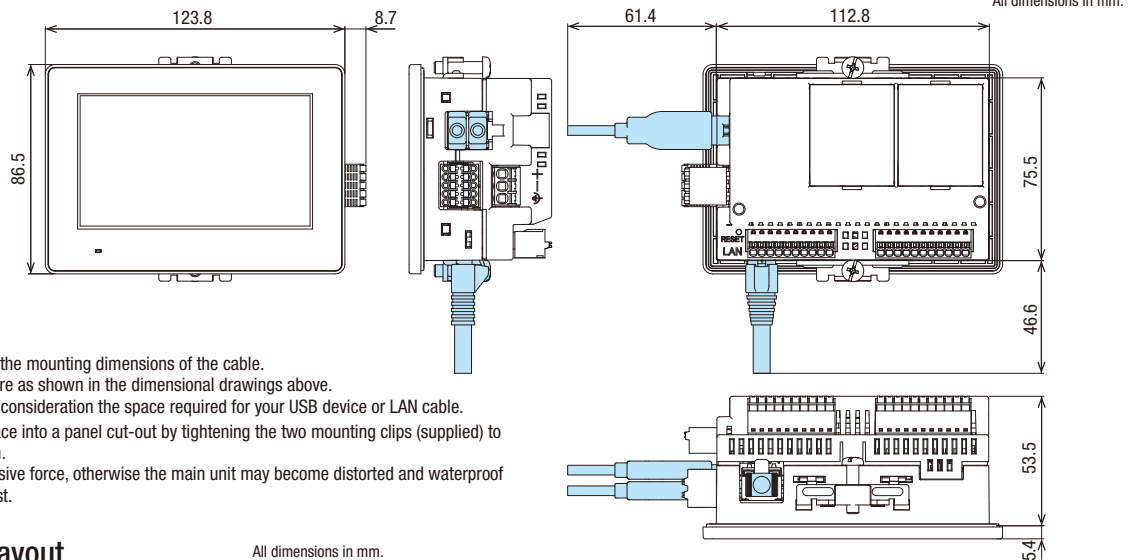

- Dimensions in blue show the mounting dimensions of the cable.
USB and LAN interfaces are as shown in the dimensional drawings above.
When installing, take into consideration the space required for your USB device or LAN cable.
- Install the operator interface into a panel cut-out by tightening the two mounting clips (supplied) to a torque of 0.3 to 0.4 N-m.
Do not tighten with excessive force, otherwise the main unit may become distorted and waterproof characteristics may be lost.

Mounting hole layout

All dimensions in mm.

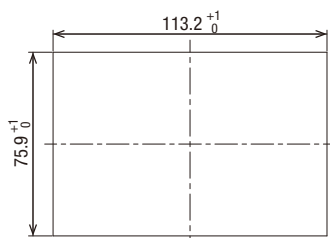

Panel Thickness: 1.0 to 5.0mm

General Specifications

Electrical	Rated power voltage	24V DC
	Power voltage range	20.4 to 28.8V DC
	Power consumption	Backlight off 3W maximum when not using USB1, USB2, IN, OUT, Slot 1, Slot 2
		5W when not using USB1, USB2, IN, OUT, Slot 1, Slot 2 13W maximum (FT1J-4F12RAG-*) 15W maximum (FT1J-4F14KAG-*, FT1J-4F14SAG-*)
Allowable instantaneous blackout period	10ms maximum (power supply voltage: 24.0V DC) 5ms maximum (power supply voltage: 20.4V DC)	
Inrush Current	40A maximum	
Environmental	Operating temperature	-20 to +55°C (no freezing) (*1)
	Operating humidity	10 to 95%RH (no condensation) (*2)
	Storage temperature	-20 to +70°C (no freezing) (*1)
	Storage humidity	10 to 95%RH (no condensation) (*2)
	Pollution degree	2
	Corrosion immunity	Free from corrosive gases
Mechanical	Vibration resistance	5 to 8.4Hz single amplitude 3.5mm, 8.4 to 150Hz acceleration 9.8m/s ² (10 times each in 3 axes) (IEC 61131-2)
	Shock resistance	FT1J-4F12RAG-*: 98m/s ² 11ms FT1J-4F14KAG-*, FT1J-4F14SAG-*: 147m/s ² 11ms (3 times in each in 3 axes) (IEC 61131-2)
Noise	First transient/burst	±2kV (power supply terminal) ±1kV (communication line)
	Electrostatic discharge	±6kV (contact discharge) ±8kV (air discharge)
Structure	Mounting	Panel mount (panel thickness: 1.0 to 5.0mm)
	Degree of Protection	When panel thickness is between 1mm and 1.6mm: IP65F (IEC 60529) When panel thickness is between 1.6mm and 5mm: IP66F, IP67F (IEC 60529), TYPE 4X (indoor use only), TYPE 13
	Dimensions	123.8 (W) x 86.5 (H) x 58.9 (D) mm
	Weight (approx.)	320g

- *1) Avoid prolonged use of the product in direct sunlight, as this can increase the surface temperature of the display above the ambient temperature, causing touch panel malfunctions.
- *2) Avoid using the product in areas exposed to excessive hot water, as sudden temperature changes can cause condensation inside the product, leading to malfunctions.

Display Specifications

Display	TFT color LCD	
Color / Shade	16,770,000 colors (24-bit color)	
Effective display area	95.04 (W) x 53.856 (H) mm	
Display resolution	480 (W) x 272 (H) dot	
Dot pitch	0.198 (W) x 0.198 (H) mm	
View angle	Left/right/top/bottom: 80°	
Backlight	White LED	
Backlight life	50,000 hours standard	
Brightness	500 cd/m ² (Typ.)	
Brightness adjustment	32 levels	
Character code	Shift_JIS (Japanese)	ANSI 1250 (Central European)
	ISO 8859-1 (European)	ANSI 1257 (Baltic)
	GB2312 (Simplified Chinese)	ANSI 1251 (Cyrillic)
	BIG5 (Traditional Chinese)	ASCII (7 seg)
	KSC5601 (Hangul)	
Number of display characters	Font size 16 (default): 60 characters x 11 lines	
Character attribute	Bold, shadowed, blink (1 or 0.5 sec period)	
Graphics	Straight line, continuous line, rectangle, circle, arc, fan, ellipse, equilateral polygon (3, 4, 5, 6, 8), bitmap shape	
Window display	3 popup screens + 1 system screen	

Operation Specifications

Switching element	PCAP touchscreen (projected capacitive)
Multiple press	Up to 2 points
Acknowledgment sound	Electronic buzzer

Function Specifications

Screen types	Base screen, popup screen, system screen
Number of screens	Base screen: 3000 maximum Popup screen: 3015 maximum
User memory	HMI function :24MB approx. Control function : 96KB (equivalent to 12,000 steps)
Parts	Bit Button, Word Button, Goto Screen, Print Button, Key Button, Multi Button, Keypad, Numerical Input, Character Input, Pilot Lamp, Multi-State Lamp, Picture Display, Message Display, Message Switching Display, Alarm List Display, Alarm Log Display, Data Log Display, Numerical Display, Bar Graph, Trend Chart, Pie Chart, Meter, Calendar, Bit Write Command, Word Write Command, Goto Screen Command, Print Command, Timer, Screen Script Command, Multi Command
Backup data (Stored in nonvolatile memory)	HMI function: HMI keep relay, HMI keep register, log data Control function: Internal relay, shift register, counter, data register, special data register, special internal relay
Calendar (Stored in a large capacity capacitor)	Year, Month, Day, Hour, Min., Sec., Day of Week ±60 sec per month (at 25°C)
Clock backup time	20 days (at operating temperature of 25°C) (*3)

*3) If the power is cut off for a certain amount of time, the clock data will be initialized to "00:00:00 January 1, 2000" at the next start up. Log data, HMI keep relay, HMI keep register is stored in a volatile memory so there is no backup time limit.

Interface Specifications

Serial interface (COM) (*4)	RS232C	Electrical characteristics	EIA RS232C compliant
		Transmission speed	1200/2400/4800/9600/ 19,200/38,400/57,600/ 115,200/187,500 bps (*5)
		Synchronization	Asynchronous
		Communication method	Half or full duplex
		Control system	Hardware control or none
		Connector	Detachable 10-pin terminal block
	RS422 / 485	Electrical characteristics	EIA RS422/485 compliant
		Transmission speed	1200/2400/4800/9600/ 19,200/38,400/57,600/ 115,200/187,500 bps (*5)
		Synchronization	Asynchronous
		Communication method	Half or full duplex
		Control system	None
		Connector	Detachable 10-pin terminal block
Ethernet interface (LAN)	Interface specifications	IEEE802.3u (10BASE-T/100BASE-TX) compliant	
	Connector	Modular jack (RJ-45)	
USB interface (USB1) (*6)	Interface specifications	USB2.0 High speed (480Mbps)	
	Connector	USB Type A connector	
USB interface (USB2) (*6)	Interface specifications	USB2.0 High speed (480Mbps)	
	Connector	USB Type A connector	

- *4) RS232C and RS 422/485 can be used simultaneously
- *5) 187,500 bps is available only with SIEMENS SIMATIC S7-300/400 series (MPI port direct connection).
- *6) USB output current varies depending on the mounting direction and ambient temperature.

Serial Interface Connector Terminal Arrangement

Name	I/O	Function	Communication
SD	OUT	Sent data	RS232C
RD	IN	Receive data	
RS	OUT	Request to send	
CS	IN	Clear to send	
SG	-	Signal ground	RS422/485
SDA	OUT	Send data "+"	
SDB	OUT	Send data "-"	
RDA	IN	Receive data "+"	
RDB	IN	Receive data "-"	
SG	-	Signal ground	

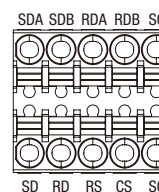

Performance Specifications

Part No.		FT1J-4F14KAG-*	FT1J-4F14SAG-*	FT1J-4F12RAG-*	
Instruction words (control function)	Basic instructions	42			
	Advanced instructions	109			
Number of user program downloads		1000 times			
Processing time (control function)	Basic instructions	100µs/1000 steps			
	END processing	2ms			
Built-in I/O points	Input	Digital	6 point (source) 6 point (sink)		
		Analog/Digital common	2 (0 to 10V DC/4 to 20mA, 12-bit resolution) / (sink)		
	Output	Relay	–	–	4 (2A)
		Transistor sink	4	–	–
		Transistor source	–	4	–
Analog	2 (0-10V DC/4-20mA, 12-bit resolution)		–		
Cartridge	Number of slots	2			
	Connectable cartridge types	7 (Digital I/O cartridges: 3 analog I/O cartridges: 4)			
	Expandable I/O points	Digital I/O: 8 maximum Analog I/O: 4 maximum			
High-speed counter	Single/two-phase common	1 (2 times: 10kHz, 4 times: 5kHz)			
	Single phase only	4 (20kHz)			
Pulse output	Number of points	4	–	–	
	Maximum response frequency	20KHz	–	–	
	Function	PULS and PWM instructions	–	–	
Number of devices (control function)	Internal relay	6400			
	Special internal relay	144			
	Shift register	128			
	Data register	4000			
	Special data register	200			
	Additional/reversible counters	200			
Timer (1ms, 10ms, 100ms, 1s)	200				

Input Specifications

Part No.		FT1J-4F14KAG-*	FT1J-4F14SAG-*	FT1J-4F12RAG-*	
Digital input	Input points	6			
	Input type	Source	Sink		
	Input voltage range	0 to 28.8V DC			
	Rated input current	I0 to I5	5.2mA/ 1 point	4.6mA/ 1 point	
	Input impedance	I0 to I5	4.7kΩ	5.2kΩ	
	Input delay time	OFF → ON	I0 to I5: 25µs + soft filter setting		
		ON → OFF	I0 to I5: 25µs + soft filter setting		
	Isolation	Between input terminals	Not isolated		
		Internal circuit	Not isolated		
	Input type	Type1 (IEC 61131-2)			
	External load for I/O interconnection		Not needed		
	Operating level	OFF voltage	5V DC maximum		
ON voltage		15V DC minimum			
OFF current		1.0mA maximum			
ON current		2.9mA minimum	3.0mA minimum		
Analog input (common digital input)	Number of inputs	2			
	Input style	Voltage/current input (selectable)			
	Input range	0 to 10V DC / 4 to 20mA			
	Sampling duration time	5ms maximum			
	Total input delay time	6ms + 1 scan time			
	Analog resolution		4096 (12 bit)		
	Input error	25°C	±3% of full scale		
		Total	±5% of full scale		
	Isolation	Between input terminals	Not isolated		
		Internal circuit	Not isolated		
	When used as digital input	Digital input type	Type 1 (not conforming to IEC 61131-2)		
		Operating Level	OFF voltage	5V DC maximum	
ON voltage			15V DC minimum		
OFF current			0.06mA maximum		
ON current			0.20mA minimum		

Output Specifications

Transistor output	Output type / points	Transistor sink	4	
		Transistor source	4	
	Rated load voltage	24V DC		
	Input voltage range	20.4 to 28.8V DC		
	Maximum load current	1 point	0.5A maximum	
		1 common	2A maximum	
	Voltage drop (ON voltage)	1V maximum (voltage between COM and output terminals when on)		
	Maximum inrush current	1A		
	Leakage current	0.1mA maximum		
	Inductive load	L/R = 10ms (28.8V DC, 1Hz)		
Relay output (2)	External current draw	100mA maximum 24V DC		
	Isolation	Photocoupler-isolated		
	Output delay time	OFF → ON	Q0 to Q3: 25µs maximum	
		ON → OFF	Q0 to Q3: 25µs maximum	
	Output points	4		
	Rated load current	240V AC 2A	30V DC 2A	
		1mA/5V DC (reference value)		
	Initial contact resistance	30mΩ maximum		
	Electrical life	100,000 times min. (resistance load: 1800 operations/hour)		
	Mechanical Life	20 million times min. (no load: 18,000 operations/hour)		
Analog output	Output points	2 points		
	Output type	Voltage/current output (selectable)		
	Output range	0 to 10V DC / 4 to 20mA		
	Output load impedance	2kΩ minimum (voltage)	500Ω maximum (current)	
		Resistive load		
	Maximum error at 25°C	±0.3% of full scale		
	Temperature coefficient	±0.02% of full scale/°C		
	Reproducibility after stability time	±0.4% of full scale		
	Non-linearity	±0.01% of full scale		
	Output ripple	30mV maximum		
Overshoot	0% (*1)			
Overall accuracy	±1.0% of full scale			
Effects of improper output connection	None			
Digital resolution	4096 (12 bit)			
Monotonicity	Yes			
Open current loop	Cannot be detected			

*1) Overshoot may occur under light load conditions. Overshoot can be suppressed by inserting a damping resistor.
Damping resistor value: approx. 150Ω including the input impedance.

*2) If the output voltage exceeds 200V AC, use adjacent COMs with a single power supply.

7.0-inch wide FT2J Controller with Operator Interface

Control and HMI functions in one with uncompromising design for a wide range of applications

Brightness 500 cd/m ²	TFT 65,536 colors	LED 50,000 hours	48-level Brightness Adjustment
Real Parts	Outlined Font	WVGA 800×480	Serial Interface
Ethernet	USB A 2 ports	USB Memory	User Memory 24MB/36KB
Front Panel Maintenance	Operating Voltage 24V DC	Operating Temperature -20~+55°C	Portrait
Bezel color	Black		



No.	Name
(1)	POWER LED
(2)	Display
(3)	Touchscreen
(4)	Serial interface (COM)
(5)	USB interface (USB1)
(6)	USB interface (USB2)
(7)	Ethernet interface (LAN)
(8)	Power supply terminal
(9)	Mounting bracket mounting position
(10)	Reset switch
(11)	Input terminal (IN)
(12)	Output terminal (OUT)
(13)	Cartridge slot (Slot 1)
(14)	Cartridge slot (Slot 2)

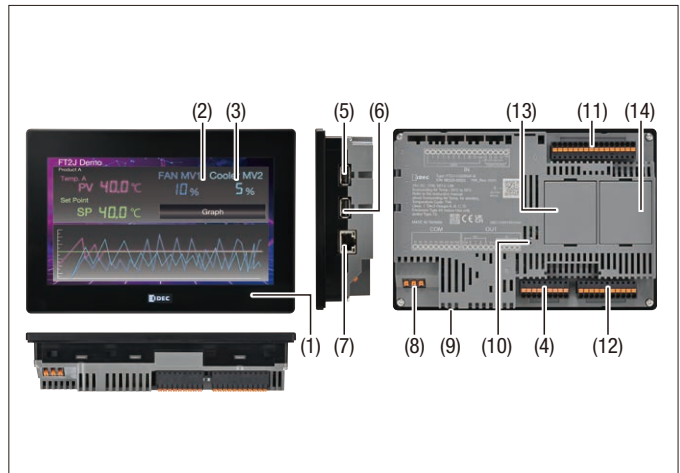

FT2J

Quantity: 1

Display screen	Operation style	Communication interface	Bezel color	Approvals	Input specifications		Output	Part No.
					Digital input	Analog input		
7-inch wide TFT color LCD 65,536 colors	PCAP touchscreen (Projected capacitive)	Serial interface (RS232C, RS422/485), Ethernet, USB	Black	UL 61010-1 UL 61010-2-201 UL 121201 CSA C22.2 No.61010-1-12 CSA C22.2 No.61010-2-201 CSA C22.2 No.213	10 point (sink/source)	4 point	8 point 2A relay output	FT2J-7U22RAF-B
							6 point transistor sink output 2 point analog output	FT2J-7U22KAF-B
							6 point transistor source output 2 point analog output	FT2J-7U22SAF-B

Dimensions

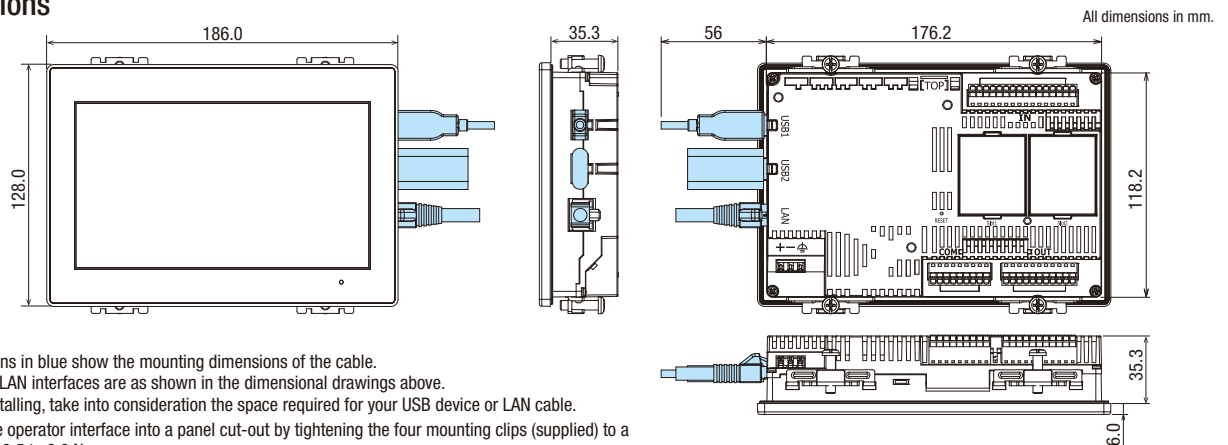

- Dimensions in blue show the mounting dimensions of the cable. USB and LAN interfaces are as shown in the dimensional drawings above. When installing, take into consideration the space required for your USB device or LAN cable.
- Install the operator interface into a panel cut-out by tightening the four mounting clips (supplied) to a torque of 0.5 to 0.6 N·m. Do not tighten with excessive force, otherwise the main unit may become distorted and waterproof characteristics may be lost.

Mounting hole layout

All dimensions in mm.

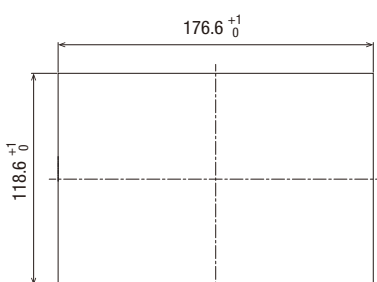

Panel Thickness: 1.0 to 5.0mm

General Specifications

Electrical	Rated power voltage	24V DC	
	Power voltage range	20.4 to 28.8V DC	
	Power consumption	Backlight off 3W maximum when not using USB1, USB2, IN, OUT, Slot 1, Slot 2	
		5W when not using USB1, USB2, IN, OUT, Slot 1, Slot 2 17W maximum	
	Allowable instantaneous blackout period	10ms maximum (power supply voltage: 24.0V to 28.8V DC) 5ms maximum (power supply voltage: 20.4V to 24.0V DC)	
Inrush Current	40A maximum		
Environmental	Dielectric strength	500V AC, 5mA, 1 minute between power and FG terminals	
		500V AC, 5mA, 1 minute between input and FG terminals	
		2300V AC, 5mA, 1 minute between relay output and FG terminals	
		500V AC, 5mA, 1 minute between transistor output and FG terminals	
		500V AC, 5mA, 1 minute between power and input terminals	
	Operating temperature	-20 to +55°C (no freezing) (*1)	
		Operating humidity	10 to 95%RH (no condensation) (*2)
		Storage temperature	-20 to +70°C (no freezing) (*1)
		Storage humidity	10 to 95%RH (no condensation) (*2)
		Pollution degree	2
Mechanical	Vibration resistance	5 to 8.4Hz single amplitude 3.5mm, 8.4 to 150Hz acceleration 9.8m/s ² (10 times each in 3 axes) (IEC 61131-2)	
		Shock resistance	147m/s ² 11ms (3 times in each in 3 axes) (IEC 61131-2)
	Noise	First transient/burst	±2kV (power supply terminal) ±1kV (communication line)
Electrostatic discharge		±6kV (contact discharge) ±8kV (air discharge)	
Structure	Mounting	Panel mount (panel thickness: 1.0 to 5.0mm)	
	Degree of Protection	When panel thickness is between 1mm and 1.6mm: IP65F (IEC 60529) When panel thickness is between 1.6mm and 5mm: IP66F, IP67F (IEC 60529), TYPE 4X (indoor use only), TYPE 13	
	Dimensions	186 (W) x 128 (H) x 41.3 (D) mm	
	Weight (approx.)	600g	

*1) Avoid prolonged use of the product in direct sunlight, as this can increase the surface temperature of the display above the ambient temperature, causing touch panel malfunctions.

*2) Avoid using the product in areas exposed to excessive hot water, as sudden temperature changes can cause condensation inside the product, leading to malfunctions.

Display Specifications

Display	TFT color LCD	
Color / Shade	65,536 colors (16-bit color)	
Effective display area	154.08 (W) x 85.92 (H) mm	
Display resolution	800 (W) x 480 (H) dot	
Dot pitch	0.1926 (W) x 0.179 (H) mm	
View angle	Left/right/top: 80°, bottom 60°	
Backlight	White LED	
Backlight life	50,000 hours standard	
Brightness	500 cd/m ² (Typ.)	
Brightness adjustment	48 levels	
Character code	Shift_JIS (Japanese)	ANSI 1250 (Central European)
	ISO 8859-1 (European)	ANSI 1257 (Baltic)
	GB2312 (Simplified Chinese)	ANSI 1251 (Cyrillic)
	BIG5 (Traditional Chinese)	ASCII (7 seg)
	KSC5601 (Hangul)	
Number of display characters	Font size 16 (default): 100 characters x 20 lines	
Character attribute	Bold, shadowed, blink (1 or 0.5 sec period)	
Graphics	Straight line, continuous line, rectangle, circle, arc, fan, ellipse, equilateral polygon (3, 4, 5, 6, 8), bitmap shape	
Window display	3 popup screens + 1 system screen	

Operation Specifications

Switching element	PCAP touchscreen (projected capacitive)
Multiple press	Up to 2 points
Acknowledgment sound	Electronic buzzer

Function Specifications

Screen types	Base screen, popup screen, system screen
Number of screens	Base screen: 3000 maximum Popup screen: 3015 maximum
User memory	HMI function :24MB approx. Control function : 96KB (equivalent to 12,000 steps)
Parts	Bit Button, Word Button, Goto Screen, Print Button, Key Button, Multi Button, Keypad, Numerical Input, Character Input, Pilot Lamp, Multi-State Lamp, Picture Display, Message Display, Message Switching Display, Alarm List Display, Alarm Log Display, Data Log Display, Numerical Display, Bar Graph, Trend Chart, Pie Chart, Meter, Calendar, Bit Write Command, Word Write Command, Goto Screen Command, Print Command, Timer, Screen Script Command, Multi Command
Backup data (Stored in nonvolatile memory)	HMI function: HMI keep relay, HMI keep register, log data Control function: Internal relay, shift register, counter, data register, special data register, special internal relay
Calendar (Stored in a large capacity capacitor)	Year, Month, Day, Hour, Min., Sec., Day of Week ±60 sec per month (at 25°C)
Clock backup time	20 days (at operating temperature of 25°C) (*3)

*3) If the power is cut off for a certain amount of time, the clock data will be initialized to "00:00:00 January 1, 2000" at the next start up. Log data, HMI keep relay, HMI keep register is stored in a volatile memory so there is no backup time limit.

Interface Specifications

Serial interface (COM) (*4)	RS232C	Electrical characteristics	EIA RS232C compliant
		Transmission speed	1200/2400/4800/9600/ 19,200/38,400/57,600/ 115,200/187,500 bps (*5)
		Synchronization	Asynchronous
		Communication method	Half or full duplex
		Control system	Hardware control or none
	RS422 / 485	Electrical characteristics	EIA RS422/485 compliant
		Transmission speed	1200/2400/4800/9600/ 19,200/38,400/57,600/ 115,200/187,500 bps (*5)
		Synchronization	Asynchronous
		Communication method	Half or full duplex
		Control system	None
Connector		Detachable 9-pin terminal block	
Ethernet interface (LAN)	Interface specifications		IEEE802.3u (10BASE-T/100BASE-TX) compliant
	Connector		Modular jack (RJ-45)
USB interface (USB1) (*6)	Interface specifications		USB2.0 High speed (480Mbps)
	Connector		USB Type A connector
USB interface (USB2) (*6)	Interface specifications		USB2.0 High speed (480Mbps)
	Connector		USB Type A connector

*4) RS232C and RS 422/485 can be used simultaneously

*5) 187,500 bps is available only with SIEMENS SIMATIC S7-300/400 series (MPI port direct connection).

*6) USB output current varies depending on the mounting direction and ambient temperature.

Serial Interface Connector Terminal Arrangement

Name	I/O	Function	Communication
SD	OUT	Sent data	RS232C
RD	IN	Receive data	
RS	OUT	Request to send	
CS	IN	Clear to send	
SG	-	Signal ground	RS232C, RS422/485
SDA	OUT	Send data "+"	RS422/485
SDB	OUT	Send data "-"	
RDA	IN	Receive data "+"	
RDB	IN	Receive data "-"	

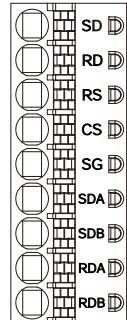

Performance Specifications

Part No.		FT2J-7U22RAF-B	FT2J-7U22KAF-B	FT2J-7U22SAF-B	
Instruction words (control function)	Basic instructions	42			
	Advanced instructions	109			
Number of user program downloads	Basic instructions	1000 times			
	END processing	2ms			
Processing time (control function)	Digital	10 (sink/source common)			
	Analog/Digital common	4 (0 to 10VDC/4 to 20mA, 12-bit resolution) / (sink)			
Built-in I/O points	Input	Relay	8 (2A)	-	
		Transistor sink	-	6	
	Output	Transistor source	-	-	6
		Analog	-	2 (0-10V DC/4-20mA, 12-bit resolution)	
Cartridge	Number of slots	2			
	Connectable cartridge types	7 (Digital I/O cartridges: 3 analog I/O cartridges: 4)			
	Expandable I/O points	Digital I/O: 8 maximum Analog I/O: 4 maximum			
High-speed counter	Single/two-phase common	1 (2 times: 10kHz, 4 times: 5kHz)			
	Single phase only	4 (20kHz)			
Pulse output	Number of points	-	4		
	Maximum response frequency	-	20KHz		
	Function	-	PULS and PWM instructions		
Number of devices (control function)	Internal relay	6400			
	Special internal relay	144			
	Shift register	128			
	Data register	4000			
	Special data register	200			
	Additional/reversible counters	200			
	Timer (1ms, 10ms, 100ms, 1s)	200			

Input Specifications

Digital input	Input points	10		
	Input type	Sink/source		
	Input voltage range	0 to 28.8V DC		
	Rated input current	I0 to I5: 4mA / 1 point I6, I7, I10, I11: 5mA / 1 point		
	Input impedance	I0 to I5: 5.6kΩ I6, I7, I10, I11: 4.3kΩ		
	Input delay time	OFF → ON	I0 to I5: 25μs + soft filter setting I6, I7, I10, I11: 100μs + soft filter setting	
		ON → OFF	I0 to I5: 25μs + soft filter setting I6, I7, I10, I11: 100μs + soft filter setting	
	Isolation	Between input terminals	Not isolated	
		Internal circuit	Photocoupler-isolated	
	Input type	Type1 (IEC 61131-2)		
	External load for I/O interconnection	Not needed		
	Operating level	OFF voltage	5V DC maximum	
		ON voltage	15V DC minimum	
		OFF current	I0 to I5: 0.5mA maximum I6, I7, I10, I11: 0.9mA maximum	
ON current		I0 to I5: 2.2mA minimum I6, I7, I10, I11: 3.2mA minimum		
Analog input (common digital input)	Number of inputs	4		
	Input style	Voltage/current input (selectable)		
	Input range	0 to 10V DC / 4 to 20mA		
	Sampling duration time	5ms maximum		
	Total input delay time	6ms + 1 scan time		
	Analog resolution	4096 (12 bit)		
	Input error	25°C	±3% of full scale	
		Total	±5% of full scale	
	Isolation	Between input terminals	Not isolated	
		Internal circuit	Not isolated	
	When used as digital input	Digital input type	Type 1 (not conforming to IEC 61131-2)	
		Operating level	OFF voltage	5V DC maximum
ON voltage			15V DC minimum	
OFF current			0.06mA maximum	
ON current	0.20mA minimum			

Output Specifications

Transistor output	Output type / points	Transistor sink	6
		Transistor source	6
	Rated load voltage	24V DC	
	Input voltage range	20.4 to 28.8V DC	
	Maximum load current	1 point	0.5A maximum
		1 common	3A maximum
	Voltage drop (ON voltage)	1V maximum (voltage between COM and output terminals when on)	
	Maximum inrush current	1A	
	Leakage current	0.1mA maximum	
	Inductive load	L/R = 10ms (28.8V DC, 1Hz)	
	External current draw	100mA maximum 24V DC	
	Isolation	Photocoupler-isolated	
	Output delay time	OFF → ON	Q0 to Q3: 25μs maximum Q4 to Q5: 300μs maximum
		ON → OFF	Q0 to Q3: 25μs maximum Q4 to Q5: 300μs maximum
Output points	8		
Rated load current	240V AC 2A 30V DC 2A		
Minimum switching load	1mA/5V DC (reference value)		
Initial contact resistance	30mΩ maximum		
Electrical life	100,000 times min. (resistance load: 1800 operations/hour)		
Mechanical Life	20 million times min. (no load: 18000 operations/hour)		
Output points	2 points		
Output type	Voltage/current output (selectable)		
Output range	0 to 10V DC / 4 to 20mA		
Output load impedance	2kΩ minimum (voltage) 500Ω maximum (current)		
Output load type	Resistive load		
Maximum error at 25°C	±0.3% of full scale		
Temperature coefficient	±0.02% of full scale/°C		
Reproducibility after stability time	±0.4% of full scale		
Non-linearity	±0.01% of full scale		
Output ripple	30mV maximum		
Overshoot	0% (*1)		
Overall accuracy	±1.0% of full scale		
Effects of improper output connection	None		
Digital resolution	4096 (12 bit)		
Monotonicity	Yes		
Open current loop	Cannot be detected		

*1) Overshoot may occur under light load conditions. Overshoot can be suppressed by inserting a damping resistor. Damping resistor value: approx. 150Ω including the input impedance.

Cartridge

Digital I/O Cartridge Specifications

Input Cartridge

Part No.	FC6A-PN4	
Input points	4 points (4/1 common)	
Rated input voltage	12/24V DC sink/source common	
Operating input voltage range	0 to 28.8V DC	
Rated input current	2.5mA / 1 point (12V DC) 5mA / 1 point (24V DC)	
Input impedance	4.4kΩ	
Operating level	OFF voltage	Less than 5V
	ON voltage	8.5V minimum
	OFF current	Less than 0.9mA
	ON current	1.7mA minimum (at applied voltage of 8.5V)
Input delay time (24V DC)	OFF → ON	0.5ms
	ON → OFF	0.5ms
Isolation	Between channels: Not isolated Internal circuit: Photocoupler-isolated	
I/O connection	No external load required for I/O interconnection	
Signal determination method	Static	
Effect of improper input connection	Both sink and source can be connected. However, if voltage exceeding the rated value is applied, permanent damage may be caused.	
Cartridge internal current draw	All ON	35mA (3.3V DC) 0mA (5V DC)
	All OFF	30mA (3.3V DC) 0mA (5V DC)
Cartridge internal power consumption (at 24V DC while all inputs are ON)	0.10W	
Cable length	3m in compliance with electromagnetic immunity	
Applicable rod terminal	For 1-wire: AI 0.5-6 WH (manufactured by Phoenix Contact)	
Weight (approx.)	15g	

Output Cartridge

Part No.	FC6A-PTK4	FC6A-PTS4
Output points	4 points sink output (4/1 common)	4 points source output (4/1 common)
Rated load voltage	12/24V DC	
Input voltage range	10.2 to 28.8V DC	
Load current	1 point	0.1A maximum
	1 common	0.4A maximum
Output delay time	ON → OFF	450us maximum
	OFF → ON	450us maximum
Isolation	Between input terminals: Non-isolated Internal circuit: Photocoupler-isolated	
Voltage drop (ON voltage)	1V maximum (voltage between COM and output when on.)	
Allowable inrush current	1A maximum	
Leakage current	Less than 0.1mA	
Clamping voltage	Approx. 50V	
Lamp load	2.4W maximum	
Inductive load	L / R=10ms (28.8V DC, 1Hz)	
External current draw	100mA maximum 24V DC (+V terminal supply power)	100mA maximum 24V DC (-V terminal supply power)
Overcurrent protection	No	
Cartridge internal current draw	All outputs ON	35mA (3.3V DC) 0mA (5V DC)
	All outputs OFF	30mA (3.3V DC) 0mA (5V DC)
Cartridge internal power consumption: (at 24V DC while all outputs ON)	0.10W	
Applicable rod terminal	For 1-wire: AI 0.5-6 (manufactured by Phoenix Contact)	
Weight (approx.)	15g	

Cartridge

Analog Cartridge

Performance Specifications

Part No.	FC6A-PJ2A		FC6A-PJ2CP		FC6A-PK2AV		FC6A-PK2AW	
Type	Voltage / current input		Temperature input		Voltage output		Current output	
I/O points	2		2		2		2	
Rated voltage	5.0V, 3.3V (supplied from main unit)							
Current draw	5.0V: - 3.3V: 30mA				5.0V: 70mA 3.3V: 30mA		5.0V: 185mA 3.3V: 30mA	
Weight	15g							

Input Specifications

Part No.	FC6A-PJ2A		FC6A-PJ2CP	
Type	Voltage input	Current input	Resistance thermometer	Thermocouple
Input range	0 to 10V DC	4 to 20mA DC 0 to 20mA DC	Pt100 : -200 to +850°C Pt1000: -200 to +600°C Ni100 : -60 to +180°C Ni1000 : -60 to +180°C 3-wire RTD	K: -200 to 1300°C J: -200 to 1000°C R: 0 to 1760°C S: 0 to 1760°C B: 0 to 1820°C E: -200 to 800°C T: -200 to 400°C N: -200 to 1300°C C: 0 to 2315°C
Input impedance	1MΩ minimum	250Ω maximum	1MΩ minimum	
Allowable conductor resistance	-		10Ω maximum	-
Input detection current	-		Typ: 0.2mA, 1.0mA maximum	-
AD Conversion	Sampling duration time	10ms	250ms	
	Sampling interval	20ms	500ms	
	Total input delay time	20ms + scan time		
	Type of input	Single-ended input		
	Operation mode	Self-scan		
	Conversion method	SAR		
Input error	Maximum error at 25°C	±0.1% of full scale	±0.1% of full scale	0.1% of full scale Cold junction compensation accuracy ±4.0°C max. [Exceptions] R, S Thermocouple error: ±6.0°C (0 to 200°C range only) B Thermocouple error: not guaranteed (0 to 300°C range only) K, J, E, T, N Thermocouple error: ±0.4% of full scale (0°C or lower range only)
	Temperature coefficient	±0.02%/°C of full scale		
	Reproducibility after stabilization time	±0.5% of full scale		
	Non-linearity	±0.01% of full scale		
	Total error	±1.0% of full scale		
	Digital resolution	4096 (12 bits)	Pt100 :10500 (14 bits) Pt1000 :8000(13 bits) Ni100 :2400 (12 bits) Ni1000 :2400 (12 bits)	K: 15,000 (14 bits) J: 12,000 (14 bits) R: 17,600 (15 bits) S: 17,600 (15 bits) B: 18,200 (15 bits) E: 10,000 (14 bits) T: 6000 (13 bits) N: 15,000 (14 bits) C: 23,150 (15 bits)
	LSB input value	2.44mV (0 to 10V DC)	4.88μA (0 to 20mA DC) 3.91μA (4 to 20mA DC)	0.1°C 0.18°F
	Data format in application	Can be arbitrarily set for each channel in the range of -32,768 to 32,773		
Monotonicity	Yes			
Noise resistance	Maximum temporary Deviation during electrical noise tests	±4.0% of full scale maximum		
	Recommended cable	Shielded	-	
	Crosstalk	1 LSB maximum		
Insulation	None			
Effect when input is incorrectly wired	No damage			
Maximum allowable constant load (non-destructive)	13V DC	40mA	13V DC	
Input type modification	Soft programming			
Calibration to maintain rated accuracy	Impossible			













Output Specifications

Part No.	FC6A-PK2AV		FC6A-PK2AW	
Type	Voltage output		Current output	
Output type	Voltage output	0 to 10V DC		-
	Current output	-	4 to 20mA DC	
Load	Impedance	2kΩ minimum	500Ω maximum	
	Load type	Resistive load		
D/A conversion	Scan time	20ms		
	Settling time	40ms maximum	20ms maximum	
	Total output delay time	60ms + Scan time	40ms + Scan time	
Output error	Maximum error at 25°C	±0.3% of full scale		
	Temperature coefficient	±0.02% / °C of full scale		
	Reproducibility after stability time	±0.4% of full scale		
	Non-linearity	±0.01% of full scale		
	Output ripple	30mV maximum		
	Overshoot	0%		
	Overall accuracy	±1.0% of full scale		
	Effect of improper output terminal connection	No damage		
Data	Digital resolution	4096 (12 bits)		
	LSB output value	2.44mV (0 to 10V)	3.91μA (4 to 20mA)	
	Data format in application	0 to 4095 (0 to 10V)	0 to 4095 (4 to 20mA)	
	Monotonicity	Yes		
Noise Resistance	Open current loop	-	Not detectable	
	Maximum temporary deviation during electrical noise tests	±4.0% of full scale maximum		
	Recommended cables	Shielded		
Crosstalk	1 LSB maximum			
Isolation	None			
Calibration to maintain rated accuracy	Impossible			
Selection of output signal type	Voltage output only	Current output only		

Applicable wire

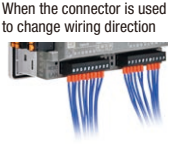
Part No.	FC6A-PJ2A	FC6A-PJ2CP	FC6A-PK2AV	FC6A-PK2AW
Applicable wires and specifications	0.3mm ² (AWG20 to 24) Shielded	0.3mm ² (AWG20 to 24) Shielded	0.3mm ² (AWG20 to 24) Shielded	

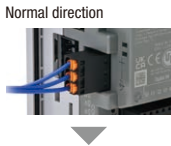
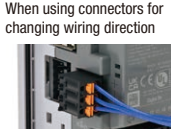
Accessories

Name / Shape		Part No.	Quantity	Specification	
System integration software		SW1A-W1C	1	Automation Organizer (Includes WindO/I-NV4)	
Protective film		HG9Z-2D7	5	For HG2J/ FT2J	Protective film to cover the panel surface. Dimensions: 182.4 x 124.4 mm Thickness: 0.153 mm
		HG9Z-1E4		For HG1J/ FT1J	Protective film to cover the panel surface. (Includes 5 pcs) Dimensions: 120.8 x 83.5 mm Thickness: 0.135 mm
FT9Z-2D7		For HG2J/ FT2J		Protective film to protect the panel surface from UV. Spray with water to attach. Dimensions: 181.4 x 123.4 mm Thickness: 0.135 mm	
FT9Z-1E4		For HG1J/ FT1J		Protective film to protect the panel surface from UV. Spray with water to attach. (Includes 5 pcs) Dimensions: 119.8 x 82.5 mm Thickness: 0.135 mm	
UV protective sheet					
USB relay port		CW1X-USB20-1M	1	Bezel color: black	Install on control panels to connect the USB connector. Cable length: 1m USB2.0 TypeA
RJ45 relay port		CW1X-RJ45	1	Bezel color: black	Install on control panels to connect the LAN cable of the RJ45 connector. Ethernet interface
Rubber cap (*1)		CW9Z-D1X1	1	Protective rubber caps for USB relay port and RJ45 relay port Material: TPE Color: black Protection: IP65/67	
Plastic cover (*1)		CW9Z-D1X2	1	Plastic cover for protection of USB relay port and RJ45 relay port Material Lens: Polycarbonate resin Body: Polyamide resin Packing: NBR Color: Translucent Protection: IP65/67	
Digital I/O cartridge	Digital input		FC6A-PN4	1	Digital input (4 points)
	Digital output		FC6A-PTK4	1	Transistor sink output (4 points)
Analog cartridge			FC6A-PTS4	1	Transistor source output (4 points)
			FC6A-PJ2A	1	Voltage current input (2 points)
			FC6A-PK2AV	1	Voltage output (2 points)
			FC6A-PK2AW	1	Current output (2 points)
	FC6A-PJ2CP	1	Temperature input (2 points)		
Connector for input terminal (for changing wiring direction)	 	FT9Z-XT10V	1	For FT1J Removable terminal block 10-pin, Screw type Not included with the main unit. Used for changing the wiring direction. (*2) (*3)	
Connector for output terminal (for changing wiring direction)	 	FT9Z-XT11V	1	For FT1J Removable terminal block 11-pin, Screw type Not included with the main unit. Used for changing the wiring direction. (*2) (*4)	
Power supply terminal connector (for changing wiring direction)	  	FT9Z-1X03V	1	For FT1J Removable terminal block 3-pin, push-in terminal Not included with the main unit. Use for changing the wiring direction.	

*1) Exclusive for CW series relay port (CW1X) and cannot be used for other models.

Refer to the instruction manual from the QR code on the right for details on how to use the product.

*2) Does not comply with UL requirements when used with FT1J-4F12RAG-B or FT1J-4F12RAG-S.

*3) Does not comply with UL requirements when FT9Z-XT10V (optional connector) is used. The tightening torque when connecting the cable is 1.7lb-in (0.2N·m).

*4) Does not comply with UL requirements when FT9Z-XT11V (optional connector) is used. The tightening torque when connecting the cable is 1.7lb-in (0.2N·m).



Maintenance Parts

Name	Shape	Part No.	Quantity	Specification
Mounting clip		HG9Z-4K2	1	For FT1J/FT2J 2 pieces (FT1J) or 4 pieces (FT2J) are included in the main unit.
Serial interface connector		HG9Z-XT09P	1	For HG2J/FT2J Removable terminal block 9-pin, push-in terminal One connector is supplied with the main unit.
		FT9Z-1T10P	1	For HG1J/FT1J Removable terminal block 10-pin, push-in terminal One connector is supplied with the main unit.
Input terminal connector		FT9Z-XT16P	1	For FT2J Removable terminal block 16-pin, push-in terminal One connector is supplied with the main unit.
		FT9Z-XT10P	1	For FT1J Removable terminal block 10-pin, push-in terminal One connector is supplied with the main unit.
Output terminal connector		FT9Z-XT11P	1	For FT1J/FT2J Removable terminal block 11-pin, push-in terminal One connector is supplied with the main unit.
Power supply terminal connector		FT9Z-1X03P	1	For HG1J/FT1J Removable terminal block 3-pin, push-in terminal One connector is supplied with the main unit.

List of PLCs that can be connected

Manufacturer	Series
IDEC	MICROSmart FC6A
	SmartAXIS FT1A Pro/Lite
	MICROSmart FC6A (Ethernet)
	SmartAXIS FT1A Pro/Lite (Ethernet)
Mitsubishi Electric	MELSEC-A (Link Unit)
	MELSEC-QnA (Link Unit)
	MELSEC-Q (Link Unit)
	MELSEC-Q (Ethernet)
	MELSEC-FX
	MELSEC-FX (Ethernet)
Omron	SYSMAC-C
	SYSMAC-CS
	SYSMAC-CJ1
	SYSMAC-CJ2
	SYSMAC-CP1
	SYSMAC (Ethernet)
Allen-Bradley	PLC-5 (Half Duplex)
	SLC-500 (Half Duplex)
	MicroLogix (Full Duplex)
	ControlLogix (Full Duplex)
	CompactLogix (Full Duplex)
	FlexLogix (Full Duplex)
	ControlLogix (Ethernet/IP, Ethernet/IP (Logix Native Tag))
	CompactLogix (Ethernet/IP, Ethernet/IP (Logix Native Tag))
	PLC-5 (Ethernet/IP)
	SLC 500 (Ethernet/IP)
MicroLogix (Ethernet/IP)	

Manufacturer	Series
SIEMENS	S7-200
	S7-300 (connected to CPU unit)
	S7-300 (link unit)
	S7-400
	S7-1200 (Ethernet)
Keyence	KV-700/1000/3000/5000/7000
	KV Nano
	KZ
	KV-10/16/24/40
	KV (Ethernet)
Shibaura Machinery	TC200
	TCmini
Modicon	Modbus RTU Master (*1)
	Modbus RTU Slave (*2)
	Modbus ASCII Master (*1)
	Modbus TCP Client (*1)
	Modbus TCP Server (*2)
Panasonic	FP Series (MEWNET)
Yaskawa Electric	MP
	MP (Ethernet)
Fuji Electric	MICREX-SX
	MICREX-SX (Ethernet)
ABB	Totalflow G4/G5 (RS232C/485)
	Totalflow G4/G5 (Ethernet)

The compatible PLC information is for reference only (except for IDEC PLCs), and IDEC does not guarantee the operation of any other manufacturers' PLC. When using other manufacturers' PLCs, read their specifications and instruction manual carefully. The PLC must be operated correctly under the user's responsibility.

The company names and product names are registered trademarks or brand names.

*1) FT1J/FT2J can be connected to slave or server devices.

*2) Master or client devices can be connected to FT1J/FT2J.

Terminal Layout and Wiring Example (For details, see the instruction manual.)

Fuse Load

FT1J-4F12RAG-*

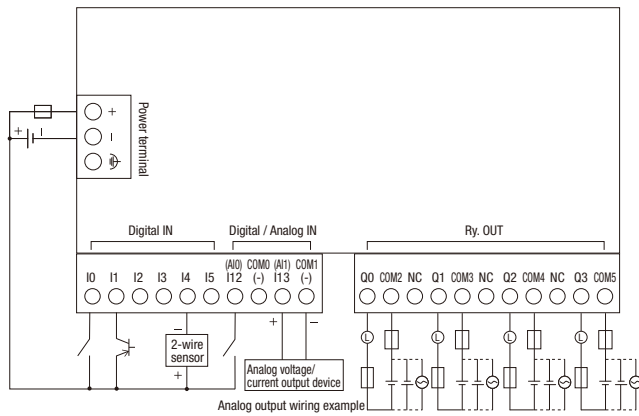

FT1J-4F14KAG-*

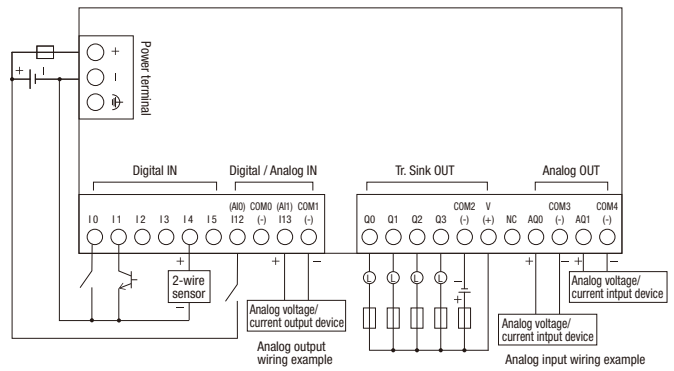

FT1J-4F14SAG-*

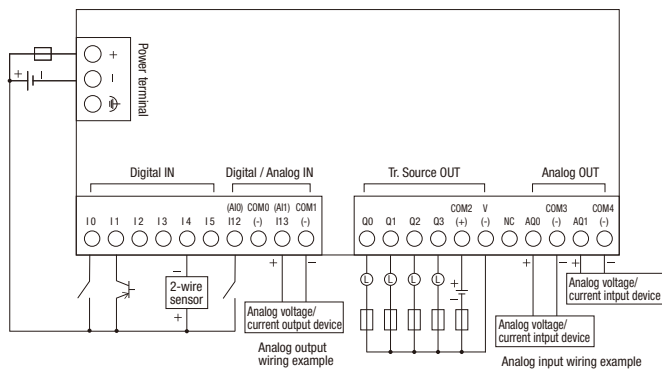

Terminal Layout and Wiring Example (For details, see the instruction manual.)

Fuse Load

FT2J-7U22RAF-B

FT2J-7U22KAF-B

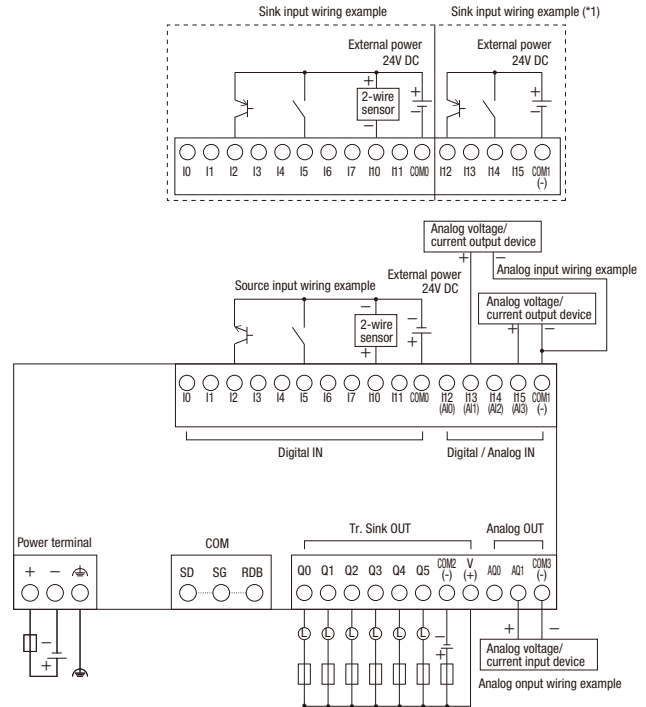
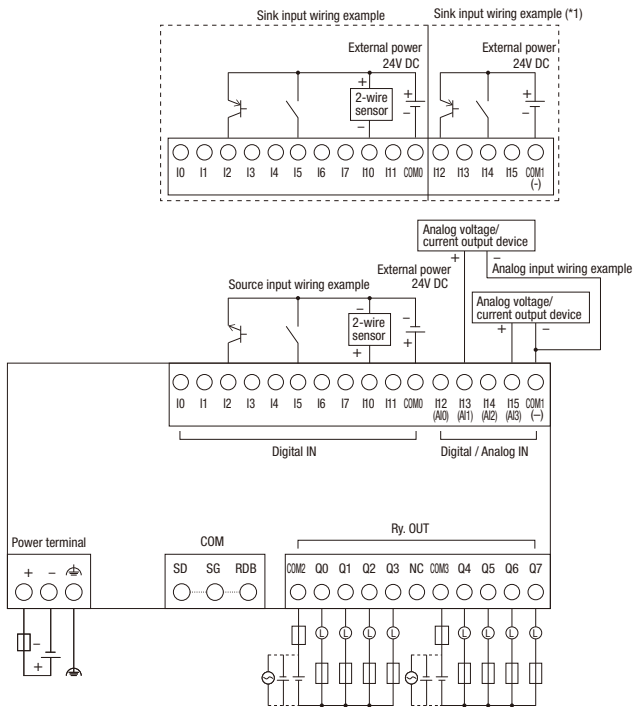

FT2J-7U22SAF-B

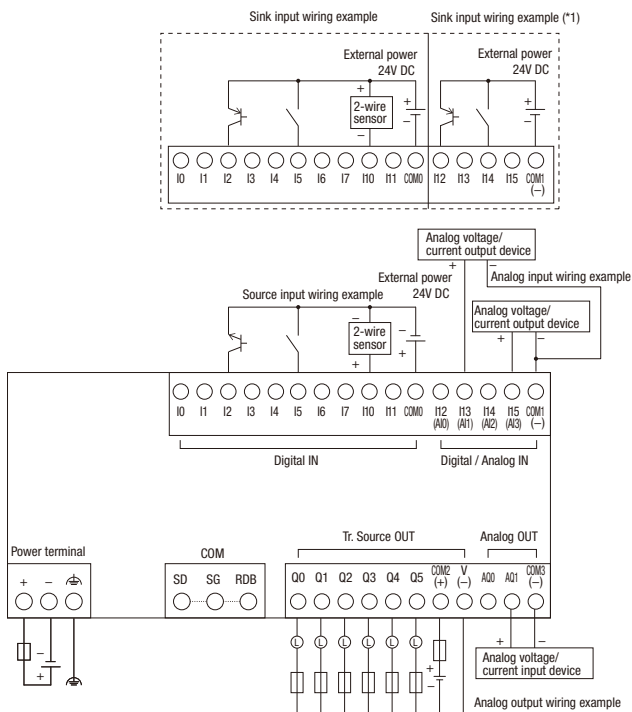

• I12 to I15 cannot be used as source inputs.

Recommended Ferrules and Crimping Tools

Applicable wire / Recommended ferrule

When wiring, use the applicable wires shown below. In addition, use the following applicable rod terminals for wiring to each terminal.

Applicable wire (*1)	Power supply unit : AWG14 to 28 Input terminal, output terminal, serial interface: AWG16 to 24		
Wire strip length (*1)	Power supply unit: 7 to 9mm Input terminal, output terminal, serial interface: 8 to 9 mm		
Recommended ferrule	IEDEC	Weidmüller	Phoenix Contact
	Part No.	Part No.	Part No.
	S3TL-H025-12WJ	H0.25/12 HBL	AI 0,25-8YE
	S3TL-H034-12WT	H0.34/12 TK	AI 0,34-8TQ
	S3TL-H05-14WA	H0.5/14 OR	AI 0,5-8WH
	S3TL-H075-14WW	H0.75/14 W	AI 0,75-8GY

*1) When single or stranded wires are used.

Recommended tools (sold separately)

Name	Part No.	Manufacturer
Insulated screwdriver	S3TL-D04-25-75	IEDEC
Crimping tool	S3TL-CR06D	IEDEC
Stripping tool	S3TL-ST06	IEDEC

Instructions

Be sure to read the instruction manual carefully before performing installation, wiring, or maintenance work.

For details on mounting, wiring, and maintenance, see the instruction manual from the below URL.

FT1J: <https://product.idec.com/?product=FT1J>

FT2J: <https://product.idec.com/?product=FT2J-7U>



FT1J



FT2J

- This product has been manufactured under strict quality control. However, if you intend to use this product in applications where failure of this equipment may result in damage to property or injury, ensure that it is used in conjunction with appropriate fail-safe backup equipment.
- Turn off the power before starting installation, removal, wiring, maintenance, and inspection of the products. There is a risk of electric shock or fire as well as damage to the equipment.
- Emergency stop and interlocking circuits must be configured outside of the FT1J/FT2J.
- Do not use touch switches and function keys for an emergency stop circuit or an interlocking circuit. If the internal circuit of the FT1J/FT2J fails, the external equipment connected to the product will no longer be protected, and serious injury to operators and equipment damage may be caused.
- Use the product within the environmental limits given in the catalog and manual. Use of the product in high-temperature or high-humidity environments, or in locations where it is exposed to condensation, corrosive gas or large shock loads, can create the risk of electrical shock or fire.
- The FT1J/FT2J is designed for use in pollution degree 2 environment (based on the IEC 60664-1 rating).
- Install the FT1J/FT2J according to the instructions in the User's Manual. Improper installation will result in falling, failure, electrical shock, fire hazard, or malfunction.
- Use a power supply of the rated value. Using an incorrect power supply may cause fire.
- The FT1J/FT2J uses "PS2" as DC power supply. (based on the IEC / EN 61131 rating)
- Use an IEC 60127 approved fuse on the power line outside the FT1J/FT2J. (Applicable when the equipment embedded with the operator interface is shipped to Europe.)
- When exporting the FT1J/FT2J to Europe, use an EU-approved circuit protector. (Applicable when the equipment embedded with the operator interface is shipped to Europe.)
- The touch panel built-in the FT1J/FT2J is made of glass. The touch panel will break if exposed to excessive shock. Be careful when handling the FT1J/FT2J.
- The protective film affixed on the display of the FT1J/FT2J is used to protect the product from scratches during transportation. Remove the protective film before use. If the protective film is not removed, depending on the operating environment, the film may become cloudy and adhere to the display part, making it difficult to remove.
- Do not press or scratch the touch panel and protection sheet with a hard object such as a tool.
- Do not install the FT1J/FT2J in areas subject to strong ultraviolet rays, as ultraviolet rays may impair the quality of the LCD.
- Note that small black and bright dots may show up on LCD Screen. This is not a failure or malfunction.
- The backlight life refers to the time until the brightness reduces by half the initial value. The backlight life is not guaranteed and refers to the time until the brightness reduces by half after use at 25°C. The actual life depends on operating environments and conditions.
- Protection degree refers to the front of the surface after mounting. Although the protection structure satisfies various testing conditions, operation is not guaranteed under certain environments. IP66F/IP67F oil proof structure satisfies oil proof test conditions listed in the appendix of Japanese Industrial Standard JIS C 0920. Operation is not guaranteed when using oil for a long period of time or oil that does not satisfy standards. Please test/check before use.
- Do not disassemble, repair or modify the product. Otherwise, electric shock, fire, or malfunction may occur.

Ordering Terms and Conditions

Thank you for using IDEC Products.

By purchasing products listed in our catalogs, datasheets, and the like (hereinafter referred to as "Catalogs") you agree to be bound by these terms and conditions. Please read and agree to the terms and conditions before placing your order.

1. Notes on contents of Catalogs

- (1) Rated values, performance values, and specification values of IDEC products listed in this Catalog are values acquired under respective conditions in independent testing, and do not guarantee values gained in combined conditions.
Also, durability varies depending on the usage environment and usage conditions.
- (2) Reference data and reference values listed in Catalogs are for reference purposes only, and do not guarantee that the product will always operate appropriately in that range.
- (3) The specifications / appearance and accessories of IDEC products listed in Catalogs are subject to change or termination of sales without notice, for improvement or other reasons.
- (4) The content of Catalogs is subject to change without notice.

2. Note on applications

- (1) If using IDEC products in combination with other products, confirm the applicable laws / regulations and standards.
Also, confirm that IDEC products are compatible with your systems, machines, devices, and the like by using under the actual conditions. IDEC shall bear no liability whatsoever regarding the compatibility with IDEC products.
- (2) The usage examples and application examples listed in Catalogs are for reference purposes only. Therefore, when introducing a product, confirm the performance and safety of the instruments, devices, and the like before use. Furthermore, regarding these examples, IDEC does not grant license to use IDEC products to you, and IDEC offers no warranties regarding the ownership of intellectual property rights or non-infringement upon the intellectual property rights of third parties.
- (3) When using IDEC products, be cautious when implementing the following.
 - i. Use of IDEC products with sufficient allowance for rating and performance
 - ii. Safety design, including redundant design and malfunction prevention design that prevents other danger and damage even in the event that an IDEC product fails
 - iii. Wiring and installation that ensures the IDEC product used in your system, machine, device, or the like can perform and function according to its specifications
- (4) Continuing to use an IDEC product even after the performance has deteriorated can result in abnormal heat, smoke, fires, and the like due to insulation deterioration or the like. Perform periodic maintenance for IDEC products and the systems, machines, devices, and the like in which they are used.
- (5) IDEC products are developed and manufactured as general-purpose products for general industrial products. They are not intended for use in the following applications, and in the event that you use an IDEC product for these applications, unless otherwise agreed upon between you and IDEC, IDEC shall provide no guarantees whatsoever regarding IDEC products.
 - i. Use in applications that require a high degree of safety, including nuclear power control equipment, transportation equipment (railroads / airplanes / ships / vehicles / vehicle instruments, etc.), equipment for use in outer space, elevating equipment, medical instruments, safety devices, or any other equipment, instruments, or the like that could endanger life or human health
 - ii. Use in applications that require a high degree of reliability, such as provision systems for gas / waterworks / electricity, etc., systems that operate continuously for 24 hours, and settlement systems
 - iii. Use in applications where the product may be handled or used deviating from the specifications or conditions / environment listed in the Catalogs, such as equipment used outdoors or applications in environments subject to chemical pollution or electromagnetic interference
If you would like to use IDEC products in the above applications, be sure to consult with an IDEC sales representative.

3. Inspections

We ask that you implement inspections for IDEC products you purchase without delay, as well as thoroughly keep in mind management/maintenance regarding handling of the product before and during the inspection.

4. Warranty

(1) Warranty period

The warranty period for IDEC products shall be three (3) years after purchase or delivery to the specified location. However, this shall not apply in cases where there is a different specification in the Catalogs or there is another agreement in place between you and IDEC.

(2) Warranty scope

Should a failure occur in an IDEC product during the above warranty period for reasons attributable to IDEC, then IDEC shall replace or repair that product, free of charge, at the purchase location / delivery location of the product, or an IDEC service base. However, failures caused by the following reasons shall be deemed outside the scope of this warranty.

- i. The product was handled or used deviating from the conditions / environment listed in the Catalogs
 - ii. The failure was caused by reasons other than an IDEC product
 - iii. Modification or repair was performed by a party other than IDEC
 - iv. The failure was caused by a software program of a party other than IDEC
 - v. The product was used outside of its original purpose
 - vi. Replacement of maintenance parts, installation of accessories, or the like was not performed properly in accordance with the user's manual and Catalogs
 - vii. The failure could not have been predicted with the scientific and technical standards at the time when the product was shipped from IDEC
 - viii. The failure was due to other causes not attributable to IDEC (including cases of force majeure such as natural disasters and other disasters)
- Furthermore, the warranty described here refers to a warranty on the IDEC product as a unit, and damages induced by the failure of an IDEC product are excluded from this warranty.

5. Limitation of liability

The warranty listed in this Agreement is the full and complete warranty for IDEC products, and IDEC shall bear no liability whatsoever regarding special damages, indirect damages, incidental damages, or passive damages that occurred due to an IDEC product.

6. Service scope

The prices of IDEC products do not include the cost of services, such as dispatching technicians. Therefore, separate fees are required in the following cases.

- (1) Instructions for installation / adjustment and accompaniment at test operation (including creating application software and testing operation, etc.)
- (2) Maintenance inspections, adjustments, and repairs
- (3) Technical instructions and technical training
- (4) Product tests or inspections specified by you

The above content assumes transactions and usage within your region. Please consult with an IDEC sales representative regarding transactions and usage outside of your region. Also, IDEC provides no guarantees whatsoever regarding IDEC products sold outside your region.

Related IDEC Products

Smart RFID Reader

KW2D



IP65 and IP67F rated for protection against water and oil. Ideal for use in harsh environments. The LED and buzzer make the operational status clear.

Bus Coupler Module

SX8R



Build the remote I/O system that meets your needs, along with compatible FC6A I/O modules.

Industrial Ethernet Switches

SX5E



Unmanaged Ethernet switches with diverse applications. Robust design and impressive versatility.

PLC

FC6A



MicroSmart Plus for control over larger machines or entire small-scale production lines. Microsmart All-in-One for high performance and usability.

IDEC CORPORATION

Head Office 6-64, Nishi-Miyahara-2-Chome, Yodogawa-ku, Osaka 532-0004, Japan

 www.idec.com

USA IDEC Corporation
EMEA APEM SAS

Singapore IDEC Izumi Asia Pte. Ltd.
Thailand IDEC Asia (Thailand) Co., Ltd.
India IDEC Controls India Private Ltd.

China IDEC (Shanghai) Corporation
IDEC Hong Kong Co. Ltd.
Taiwan IDEC Taiwan Corporation

Japan IDEC Corporation