

Dear customer,

## Safety instructions

Danger can occur when working with this punch driver due to improper handling and/or poor maintenance, which may damage the device and cause severe physical injuries. Please observe all safety instructions and contact us if you have any questions.

### Always...



- Use the punch driver for its specified use
- Check the punch, tools and tension bolt for damage and cracks before use
- Keep hands and fingers away from the punching die and punch
- Stop the punching process manually when punching holes in thin or soft metal sheets
- Wear the following protective equipment: safety goggles, gloves and sturdy shoes



- Avoid contact with cutting edges
- Follow the instructions in these operating instructions
- Train new users in the use of this device



- Clean any oil residues off the rubber handle
- Remove the battery before changing the tools
- Use genuine ALFRA batteries
- Disconnect the battery charger from the mains once the battery is charged completely
- Store the hydraulic punch in a dry place, free of corrosive substances

### Never...



- Process several sheets placed on top of each other in one punching process
- Work on objects or components that are under electrical or mechanical tension
- Work near live cables or electrical conductors
- Make changes to the device or remove information labels
- Use if damaged or parts are missing
- Damage, kink or squeeze the hydraulic hose
- Use the hand-operated hydraulic device without proper training
- Use the device if you have not read and understood these operating instructions completely
- Store or operate at temperatures below -10°C (14°F) and above 40°C (104°F)
- Bring into contact with corrosive substances
- Modify or open the battery by force
- Charge the battery near flammable substances or gases
- Use in an environment where there is a risk of explosion



### Fire hazard!

**Sparks may be generated during operation of electric motors! Flammable or explosive substances can ignite!**

## Specified conditions of use

ALFRA hand-operated punch drivers of the type **Akku-Compact Flex™ Punch Driver** are intended to be used for punching holes of different shapes in soft to medium-strength steel, aluminium and stainless steel sheets. The **Akku-Compact Flex™ Punch Driver** is designed for punching only single metal sheets and it must be used in a dry environment free of corrosive or flammable substances.

## Technical Data

<b>Prod.-No. and description:</b>	<b>02082 Akku-Compact Flex™ Battery-powered Punch Driver</b>	
<b>Max. punching force:</b>	75 kN	16800 lbs
<b>Max. hydraulic pressure:</b>	680 Bar	9850 psi
<b>Hydraulic medium:</b>	Shell-Naturelle HF-E15	
<b>Piston stroke:</b>	18 mm	0.7"
<b>Tool mounting:</b>	19 mm	3/4" – 16 UNF
<b>Weight:</b>		
Complete unit (incl. 1.5 Ah Battery)	2.5 kg	5.5 lbs
Electric drive (incl. 1.5 Ah Battery)	1.7 kg	3.75 lbs
Hydraulic punching head	0.8 kg	1.75 lbs
Li-Ion Battery 1.5 Ah	0.4 kg	0.88 lbs
<b>Battery type:</b>	18V Lithium-ion / 1.5 Ah	
<b>Battery charging time:</b>	ca. 30 min with 18V / 1.5 Ah	
<b>Punching time:</b>	Ø 22.5 MonoCut™ on 2.5 mm S235 = 2.0 s Ø 22.5 TriCut™ on 2.5 mm S235 = 5.5 s Ø 63.5 TriCut™ on 2.5 mm S235 = 10.0 s	
<b>Battery capacity with 1.5 Ah:</b>	195 x Ø 22.5 MonoCut™ on 2.5 mm S235 165 x Ø 22.5 TriCut™ on 2.5 mm S235 105 x Ø 63.5 MonoCut™ on 2.5 mm S235 65 x Ø 63.5 TriCut™ on 2.5 mm S235 170 x Ø 22.5 TwinCut™ on 1.5 mm V2A 95 x Ø 63.5 TwinCut™ on 1.5 mm V2A	
<b>Vibration:</b>	< 2.5 m/s <sup>2</sup>	
<b>Noise emission:</b>	80 dB(A) at 300 mm from drive	
<b>Operating temperature:</b>	-10°C up to +40°C	+14°F up to +104°F
<b>Special features:</b>	Express pressure safety valve up to 680 Bar Automatic return Service interval indicator	9850 psi

## Description

The **Akku-Compact Flex™ Punch driver** is a handheld battery-powered electro-hydraulic device for making holes of different shapes in soft to medium-strength steel, stainless steel and aluminium sheets. ALFRA punch drivers require little maintenance thanks to the closed hydraulic circuit and enable you to work in any position.

The flexible hand strap (K), which is attached to the drive unit (F), ensures perfect handling of the punch driver. A long hydraulic hose (C) makes punching even in difficult situations easy and comfortable. The integrated hydraulic pump is equipped with a microprocessor and generates the working pressure. The pump can be activated by pressing the Start/Stop button (D) and the necessary working pressure is built up, which pulls the load piston (A) inwards into the cylinder (B) with great force. The pressure is released by pressing the return button (E).

The LED (G) on the device base show the operating status of the punch driver. The high-performance lithium-ion battery (H) can be removed by pressing the release button (I) and is equipped with a charge level display (J). Electronic and mechanic excess pressure valves limit the maximum attainable pressure within the device and thus protect the hydraulic punch from excessive use and damage.

Perfect punching results will be achieved using the suitable ALFRA tools. An overview of our range of quality round and square punches can be found at the end of this operating manual.

### Akku-Compact Flex™ battery-powered punch driver

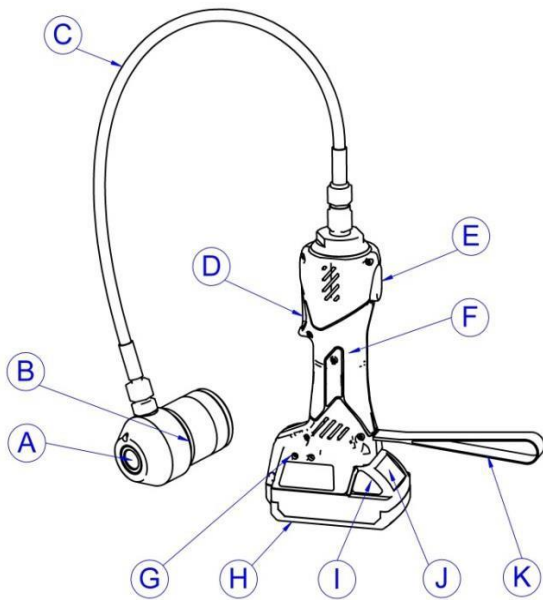

- A) Load piston
- B) Cylinder
- C) Flexible hydraulic hose
- D) Start/Stop button
- E) Return button
- F) Drive unit
- G) LED Indicator
- H) Battery
- I) Battery release
- J) Charge level display
- K) Hand strap

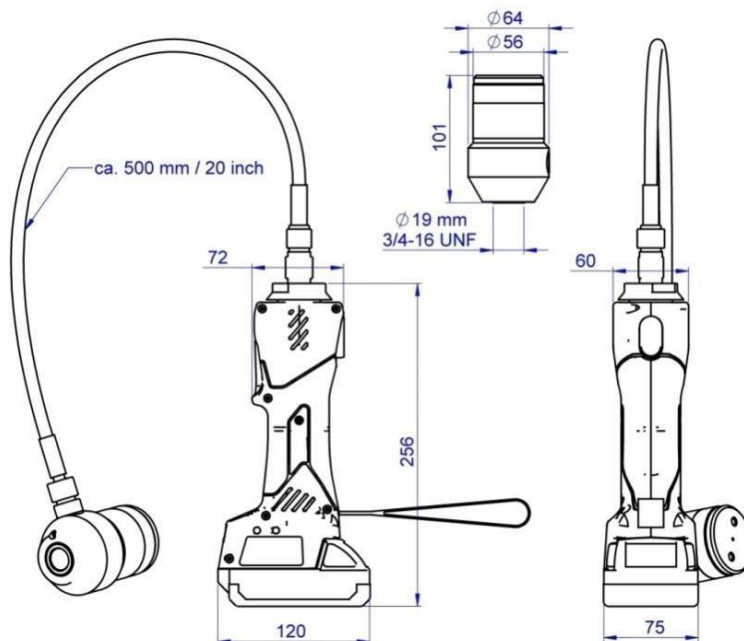

## Punching metal sheets

Gather together the appropriate tool set comprising a punch, punching die and tension bolt. We recommend the use of high-quality ALFRA tools to achieve perfect punching results.



**Do not punch more than one metal sheet at a time! Punching several layers of material in one punching process is not permitted!**

1. Mark the exact hole position for the punching.
2. Now use a spiral or step drill to make the starting hole in the metal sheet.
3. Press the return button. The load piston moves to its starting position.
4. Screw the tension bolt into the load piston by hand until it stops.  
**Always ensure that the entire length of the thread is used otherwise the tension bolt may pull out!**
5. Place the spacer and punching die on the tension bolt. Then guide the tension bolt through the prepared hole.
6. Use the hand strap as shown below and turn the punch onto the tension bolt from behind. Align the punching die with the markers.
7. Move the punch into position and screw on the punch by hand in order to fix the complete assembly in place.  
**Always ensure that the entire thread of the punch is used.**
8. Press and hold the Start/Stop button until the hole is punched.



**Risk of injury! Keep hands and fingers away from the punching die and punch whilst punching!**

9. When punching holes through thin or soft metal sheets press the return button so that the load piston will return to its starting position. With any other metal sheet load piston and punching die will return automatically.
10. Unscrew the punch and remove the scraps of material from the punching die.

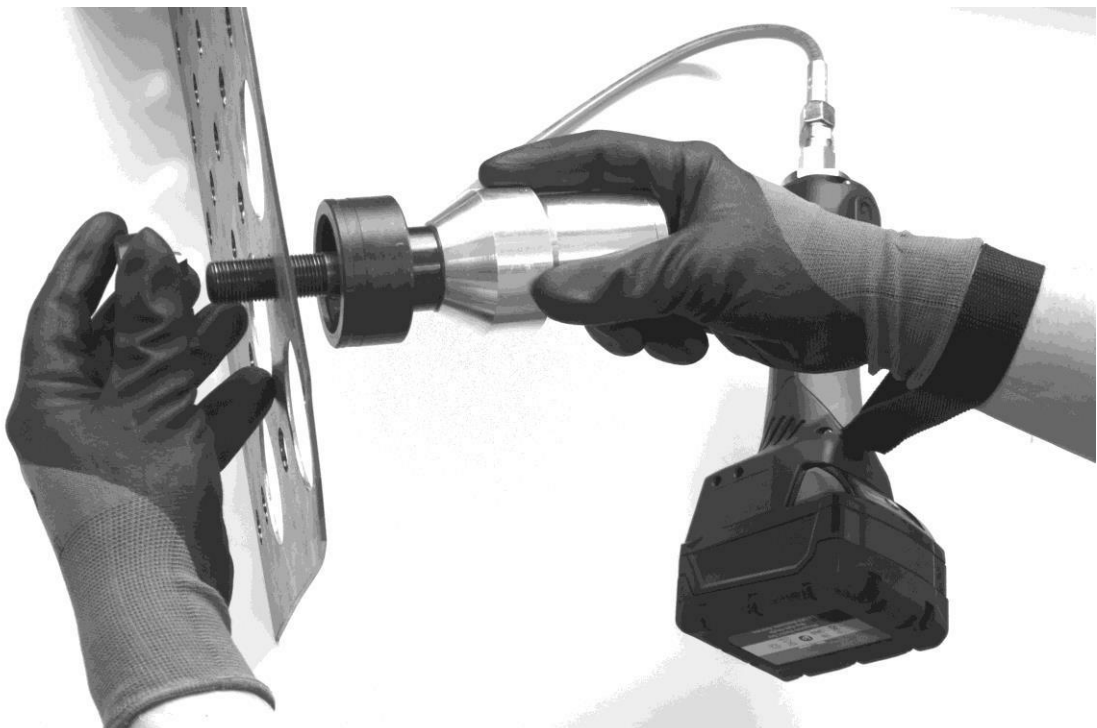

## Special features

ALFRA electro-hydraulic punch drivers offer many useful features which will facilitate your work significantly. Among the main advantages of the battery-powered **Akku-Compact Flex™ Punch Driver** are the following special features:

### Automatic return thanks to pressure sensor

Owing to an automatic return feature the load piston returns automatically in its starting position. The hydraulic pump of the **Akku-Compact Flex™ Punch Driver** is equipped with an electronic pressure sensor measuring the working pressure during the whole punching cycle. As soon as the pressure decreases after a hole is punched, the automatic return will be activated (with an after-run time of just half a second).



**Stop the punching process manually when punching holes through thin (<1.0 mm) or soft metal sheets! It is possible that the automatic return feature does not work properly!**

### Service interval indicator thanks to integrated memory

The LED on the device base reminds you in time of the regular maintenance of your **Akku-Compact Flex™ Punch Driver** thanks to an integrated memory. The non-volatile memory records the number of punching cycles. After 10.000 punching cycles the LED on the device base signals that the recommended service interval is reached. If the LED lights up green and red alternately, please send your hand-operated punch driver to ALFRA or an authorized reseller for maintenance and inspection.



**Have your hydraulic punch driver maintained by ALFRA or an authorized reseller once a year, even if you have not carried out 10.000 punching cycles!**



### Malfunction indicator LED

The LED on the device base informs you about the operating status of the **Akku-Compact Flex™ Punch Driver**. If the punch driver is operative, the LED lights up green. In case of a malfunction the LED glows red or orange and the punch driver is shut off automatically.

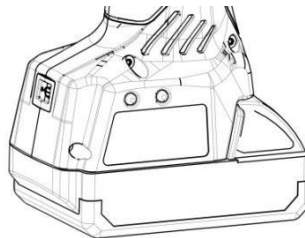



If you want to continue working with the punch driver, you need to perform a power reset: Remove the battery for a short time, then reinsert it. Should the trouble persist, please contact an authorized reseller or the ALFRA customer service. Our qualified service team will be glad to help you.



### LED after insertion of the battery

LED off		Battery without function / voltage
LED green		Punch driver is operative
LED orange		Temperature error → allow the punch driver to warm up or cool down

### LED after punching process

LED green		Punch driver is operative
LED red / green		Service interval is exceeded → device requires maintenance by the manufacturer
LED red		Operate value insufficient → contact the customer service
LED red		Operate value wrong or punch driver defective → device requires maintenance by the manufacturer
LED orange		Temperature error → allow the punch driver to warm up or cool down

## Charging the battery

The **Akku-Compact Flex™ Punch Driver** is operated with a lithium-ion battery. The ALFRA rechargeable battery is characterized by its low weight and excellent performance. Moreover, it has no memory effect. So that you can continue your work as soon as possible, the handheld punch driver is delivered together with a quick charging unit.

The battery is delivered to you partially charged. Before use please charge it completely:

1. Connect the charger at 230V / 50Hz to the electrical outlet.
2. Slide the battery into the charger. The charging process begins automatically and takes approximately 30 minutes depending on battery capacity and state of charge.
3. After charging is complete, the LED on the charger will constantly glow green. Disconnect the charger from the mains or pull the plug.

You can check the state of charge of the battery by pressing the small key next to the four LED. All of the LED will light up when the battery is charged completely. If less than four LED light up, the battery capacity is accordingly lower.

### Instructions for battery storage:

If you do not use the battery for a long period of time, please check its state of charge regularly. During longer storage of the battery we recommend an ideal state of charge of 50% to 80%. Please recharge the battery when the capacity is lower.



**Recharge the battery at least once a year to avoid a deep discharging!**



### **Fire hazard!**

**Remove all small electrical conductors (e. g. nails, paper-clips, keys or screws) from the surrounding area. Failure to do so can result in a short circuit as they can bridge the battery contacts!**

**Never charge the battery near highly flammable substances, gases or in an area where there is a risk of an explosion!**

**Only use genuine ALFRA batteries! Unsuitable batteries can reverse polarities or ignite!**



### **Risk of injury!**

**Never attempt to open the battery! The battery fluid could result in severe burnings and skin irritations! If skin or eyes are exposed to battery fluid, immediately flush with plenty of water and seek medical attention!**

## LED display on battery and charger





Quick charger

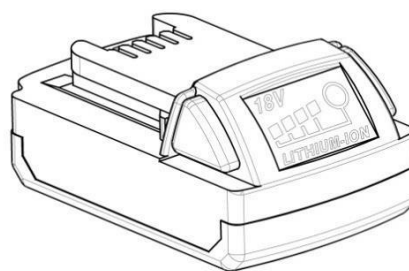



Li-Ion battery



### LED 1 and LED 2 on the charger

LED red		Battery is being charged
LED green		Battery is charged completely and operative → remove battery
LED red / green		Battery is defective → contact the customer service
LED red		Temperature error inside the battery → allow the battery to warm up or cool down
No signal		No electrical contact → battery inserted correctly? Check contacts

### LED on the battery

LED off		No error → Punch driver is operative
LED red		Battery capacity very low (ca. 10%) → charge / replace battery
LED red		Battery flat → charge / replace battery

## Cleaning and care

Regular cleaning and care will extend the lifetime of your hydraulic punch driver and the lithium ion battery. We recommend the following measures:

- Regularly remove dirt and abrasive dusts from the sliding surfaces and moving parts.
- When the punch driver is no longer used, press the return button to release the pressure.
- Check the battery charge status regularly. Recharge the battery when its capacity is too low.
- Store and use the punch driver in a dry place.

## Maintenance and repair

The hydraulic punch **Akku-Compact Flex™ Punch Driver** should be maintained and serviced after 10.000 punching cycles and at least once a year by the manufacturer to ensure safe operation. Should you need a replacement device during this time, please contact the ALFRA customer service.



**Unauthorized repairs or modification to the punch driver are not permitted!**

## EC Declaration of Conformity

We,

Alfred Raith GmbH  
2. Industriestr. 10  
68766 Hockenheim/Germany

hereby declare that the electro-hydraulic handheld punch driver

**ALFRA Akku-Compact Flex™**  
from serial number 51400027 onwards

complies with the following directives:

Machinery Directive: 2006/42/EC  
Low Voltage Directive: 2006/95/EC  
Electro-magnetic compatibility (EMC): 2004/108/EC  
RoHS Directive: 2011/65/EU

The following standards or standardization documents were applied:

EN ISO 12100 Part 1+2  
EN ISO 4413  
EN 60745-1  
EN 60529  
EN 61000-6-2  
EN 61000-6-3

Person authorized to compile the documents:

Alfred Raith GmbH  
2. Industriestr. 10  
68766 Hockenheim/Germany

Hockenheim/Germany, 22.06.2015

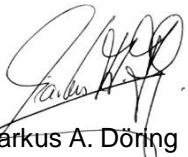

Markus A. Döring  
(Managing Director)