

IE-P70

Weidmüller Interface GmbH & Co. KG
Klingenbergstraße 26
D-32758 Detmold
Germany

www.weidmueller.com



RJ45 crimp plug-in connector according to IEC
60603-7-51 for wire outer diameters up to 1.05 mm

General ordering data

Version	RJ45 plug-in connector, with kink protection; 6.2 - 7.1 mm, Cat.6A / Class EA (ISO/IEC 11801 2010), IP20
Order No.	8813120000
Type	IE-P70
GTIN (EAN)	4032248512874
Qty.	10 items

IE-P70

Weidmüller Interface GmbH & Co. KG

Klingenbergstraße 26

D-32758 Detmold

Germany

www.weidmueller.com

Technical data

Approvals

ROHS Conform

Dimensions and weights

Net weight 5.2 g

Temperatures

Storage temperature	-40 °C...80 °C	Operating temperature	-40 °C...70 °C
Installation temperature			

Environmental Product Compliance

RoHS Compliance Status	Compliant without exemption
REACH SVHC	No SVHC above 0.1 wt%

General data

Connection 1	RJ45	Connection 2	Crimp
Description of article	with kink protection; 6.2 - 7.1 mm	Insulation cross-section, min.	0.85 mm
Insulation cross-section, max.	1.05 mm	Cable pull-out force, min.	89 N
Category	Cat.6A / Class EA (ISO/ IEC 11801 2010)	Bending protection	moulded
Contact material	Phosphorus bronze	Contact surface	Gold-plated
Connection diameter, solid	0.36...0.51 mm	Conductor connection cross-section, solid (AWG)	AWG 27...AWG 24
Connection diameter, flexible	0.46...0.61 mm	Conductor connection cross-section, flexible (AWG)	AWG 27...AWG 24
MICE classification M	M1	MICE classification I	I1
MICE classification C	C1	MICE classification E	E3
Sheath diameter, min.	6.2 mm	Sheath diameter, max.	7.1 mm
Bending protection sleeve material	PVC, UL 94-V0	Shielding material	0.5 mm brass, 2 µm nickel
Shielding	360°; all-round enclosure	Protection degree	IP20
Insertion force	20 N	Plugging cycles	750
Material insulator	Polycarbonate PC, UL 94 V-0		

Electrical properties

Contact resistance	≤ 20 mΩ	Dielectric strength, contact / shield	≥ 1500 V AC/DC
Dielectric strength, contact / contact	≥ 1000 V AC/DC	Insulation resistance	500 MΩ
Current-carrying capacity at 50 °C	1 A	PoE / PoE+	conforming to IEEE 802.3af

General standards

Connector standard IEC 60603-7-51

Classifications

ETIM 8.0	EC001121	ETIM 9.0	EC001121
ETIM 10.0	EC001121	ECLASS 14.0	27-44-03-90
ECLASS 15.0	27-44-03-90		

Dimensioned drawing

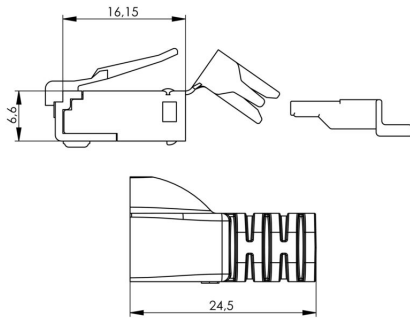

IE-P70

Weidmüller Interface GmbH & Co. KG
 Klingenbergstraße 26
 D-32758 Detmold
 Germany

www.weidmueller.com

Accessories

... for modular plug-in connectors



Crimping tools for modular plug-in connector systems WE and DEC

- Ratchet guarantees precise crimping
- Release option in the event of incorrect operation
- Three functions in one tool

General ordering data

Type	TT 8 RS MP 8	Version	
Order No.	9202800000	Pressing tools, Crimping tool for contacts	
GTIN (EAN)	4032248512072		
Qty.	1 ST		

Dust caps



For protecting your devices against dust and dirt.

General ordering data

Type	IE-PP-RJ45	Version	
Order No.	2552580000		
GTIN (EAN)	4050118562583		
Qty.	10 ST		