

DRI424524LT

Weidmüller Interface GmbH & Co. KG
Klingenbergstraße 26
D-32758 Detmold
Germany

www.weidmueller.com

Product image

Similar to illustration

Individual relays within the D-SERIES DRI

- 2 CO contact
- AC coils
- With integrated status LED and test button

General ordering data

Version	D-SERIES DRI, Relay, Number of contacts: 2, CO contact AgSnO, Rated control voltage: 24 V AC, Continuous current: 5 A, Flat blade connections (2.5 mm x 0.5 mm), Test button available: Yes
Order No.	7760056343
Type	DRI424524LT
GTIN (EAN)	6944 169739903
Qty.	20 items

DRI424524LT

Weidmüller Interface GmbH & Co. KG

Klingenbergstraße 26

D-32758 Detmold

Germany

www.weidmueller.com

Technical data

Approvals

Approvals



ROHS Conform

UL File Number Search [UL Website](#)

Certificate No. (cURus) E312083

Dimensions and weights

Depth	33.5 mm	Depth (inches)	1.3189 inch
Height	31 mm	Height (inches)	1.2205 inch
Width	13 mm	Width (inches)	0.5118 inch
Net weight	20.08 g		

Temperatures

Storage temperature	-40 °C...85 °C	Ambient temperature	-40 °C...55 °C
Operating temperature		Humidity	35...85 % rel. humidity, no condensation

Environmental Product Compliance

RoHS Compliance Status	Compliant without exemption
REACH SVHC	No SVHC above 0.1 wt%

Rated data UL

Certificate No. (cURus)	E312083
-------------------------	---------

Control side

Rated control voltage	24 V AC	Rated current AC	50 mA
Power rating	1.2 VA	Coil resistance	240 Ω ± 10 %
Status indicator	red LED		

Load side

Rated switching voltage	250 V AC	Continuous current	5 A
Max. switching frequency at rated load	0.1 Hz	Max. switching voltage, AC	250 V
Max. switching voltage, DC	250 V	AC switching capacity (resistive), max.	1250 VA
DC switching capacity (resistive), max.	150 W @ 24 V	Switch-on delay	≤ 15 ms
Switch-off delay	≤ 10 ms	Contact type	2 CO contact (AgSnO)
Mechanical service life	10 x 10 ⁶ switching cycles	Min. switching power	10 mA @ 24 V, 10 mA @ 12 V, 100 mA @ 5 V

General data

Test button available	Yes		
Version of test button	Lockable test button, Momentary test button		
Mechanical switch position indicator	No		
Colour	Transparent		
UL94 flammability rating component	Component	Relay cover	
	UL94 flammability rating	V-2	
	Component	Relay baseplate	
	UL94 flammability rating	V-0	

DRI424524LT

Weidmüller Interface GmbH & Co. KG
 Klingenbergstraße 26
 D-32758 Detmold
 Germany

www.weidmueller.com

Technical data

Component	Relay test button
UL94 flammability rating	HB

Insulation coordination

Rated voltage	300 V	Pollution severity	2
Surge voltage category	III	Insulating material group	IIIa
Clearance and creepage distances for control side - load side	≥ 4 mm	Dielectric strength for control side - load side	5 kVeff / 1 min
Dielectric strength of neighbouring contacts	1.5 kVeff / 1 min.	Dielectric strength of open contact	1 kVeff / 1 min
Impulse withstand voltage	5 kV (1.2/50 µs)	Protection degree	IP20

Further details of approvals / standards

Certificate No. (cURus)	E312083
-------------------------	---------

Connection data

Wire connection method	Flat blade connections (2.5 mm x 0.5 mm)
------------------------	---

Classifications

ETIM 8.0	EC001437	ETIM 9.0	EC001437
ETIM 10.0	EC001437	ECLASS 14.0	27-37-16-01
ECLASS 15.0	27-37-16-01		

Drawings

Wiring diagram

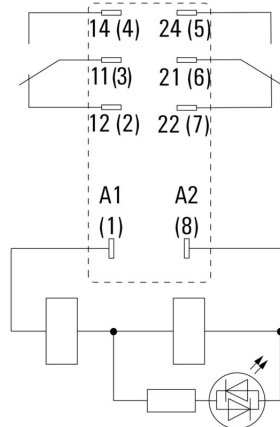

View of Pins from below

Graph

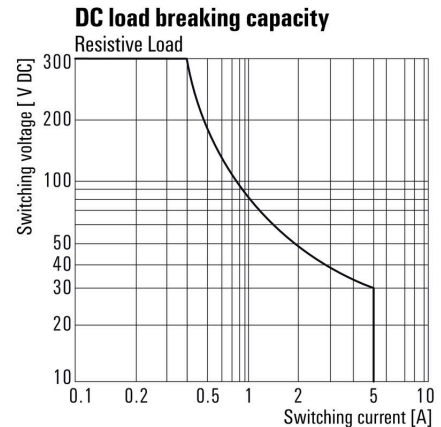

DC load limit curve Resistive load

Graph

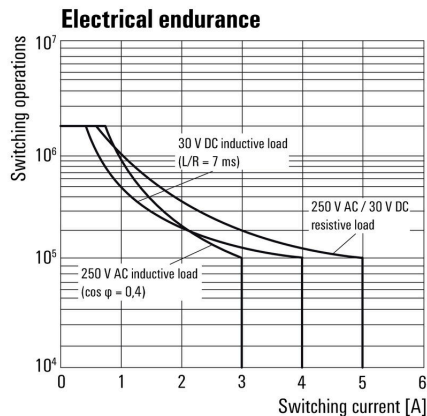

Electrical service life

Graph

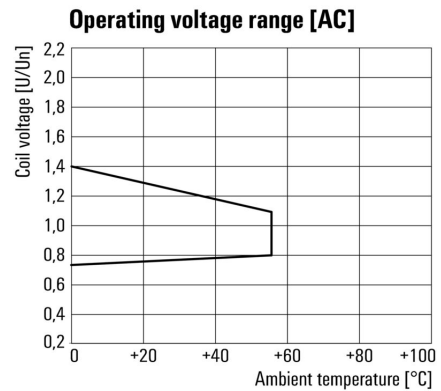

AC operational voltage range

Dimensional drawing

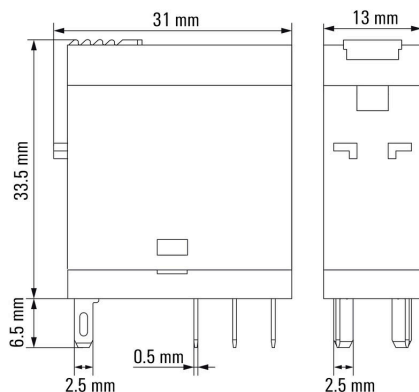

Miscellaneous

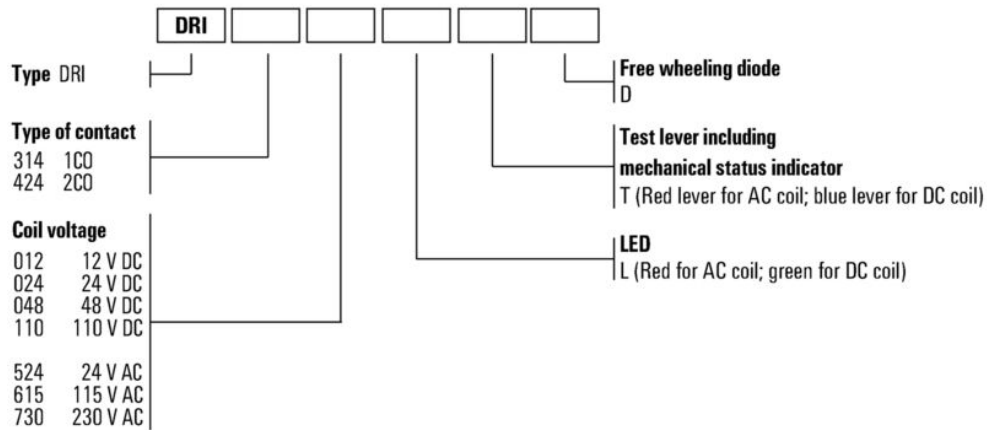

Type codes

Accessories

Sockets



Relay sockets for the D-SERIES DRI relays

- 1 and 2 CO contacts
- Screw and PUSH IN connection
- Standard and low heights

General ordering data

Type	SDI 2CO	Version
Order No.	7760056351	D-SERIES DRI, Relay socket, Number of contacts: 2, CO contact,
GTIN (EAN)	6944 169739989	Continuous current: 8 A, Screw connection
Qty.	10 ST	
Type	SDI 2CO ECO	Version
Order No.	7760056347	D-SERIES DRI, Relay socket, Number of contacts: 2, CO contact,
GTIN (EAN)	6944 169739941	Continuous current: 8 A, Screw connection
Qty.	10 ST	
Type	SDI 2CO F ECO	Version
Order No.	7760056349	D-SERIES DRI, Relay socket, Number of contacts: 2, CO contact,
GTIN (EAN)	6944 169739965	Continuous current: 8 A, Screw connection
Qty.	10 ST	
Type	SDI 2CO P	Version
Order No.	7760056365	D-SERIES DRI, Relay socket, Number of contacts: 2, CO contact,
GTIN (EAN)	6944 169772290	Continuous current: 8 A, PUSH IN
Qty.	20 ST	

LED



Pluggable protective modules for the D-SERIES relay sockets, with optional protective functions.

- With green LED

General ordering data

Type	RIM 3 6/24VUC	Version
Order No.	7940018457	D-SERIES, LED module, Rated control voltage: 6...24 V UC, Plug-in
GTIN (EAN)	4032248878192	connection
Qty.	10 ST	
Type	RIM 3 24/60VUC	Version
Order No.	7760056018	D-SERIES, LED module, Rated control voltage: 24...60 V UC, Plug-in
GTIN (EAN)	4032248878130	connection
Qty.	10 ST	

DRI424524LT

Weidmüller Interface GmbH & Co. KG

Klingenbergstraße 26

D-32758 Detmold

Germany

www.weidmueller.com

Accessories

Retaining clips



Retaining clip for D-SERIES DRI relays

- Metal and plastic retaining clip

General ordering data

Type	SDI CLIP	Version
Order No.	7760056352	D-SERIES DRI, Retaining clip
GTIN (EAN)	6944 169739996	
Qty.	10 ST	
Type	SDI CLIP P	Version
Order No.	7760056389	D-SERIES DRI, Retaining clip
GTIN (EAN)	6944 169787539	
Qty.	10 ST	
Type	SDI CLIP HM	Version
Order No.	7760056390	D-SERIES DRI, Retaining clip
GTIN (EAN)	6944 169787898	
Qty.	10 ST	

Blank

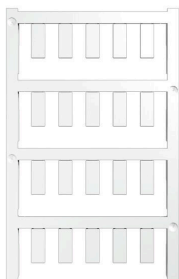

ESG is the tried-and-tested marker in MultiCard format for use on many well-known electrical devices. The result is high-quality device marking with a high-contrast appearance.

Various types are available for devices from manufacturers like Siemens, ABB, Beckhoff etc.

Advantages at a glance:

- Tags for universal usage, self-adhesive or clip-on tags, depending on type
- For aligned equipment, e.g. circuit breakers, we supply ESG markers for clipping onto tag rails
- Individual laser-quality printing according to specifications

For custom printing: Please send us a file of our labeling software M-Print PRO or M-Print PRO Online (without installation) for your labeling specifications.

General ordering data

Type	ESG 6/15 SDI MC NE WS	Version
Order No.	2558340000	ESG, Device markers x 15 mm, PA 66, Colour: white, pluggable
GTIN (EAN)	4050118569056	
Qty.	200 ST	

Accessories

Custom printing

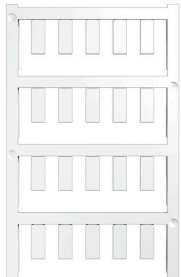

ESG is the tried-and-tested marker in MultiCard format for use on many well-known electrical devices. The result is high-quality device marking with a high-contrast appearance.

Various types are available for devices from manufacturers like Siemens, ABB, Beckhoff etc.

Advantages at a glance:

- Tags for universal usage, self-adhesive or clip-on tags, depending on type
- For aligned equipment, e.g. circuit breakers, we supply ESG markers for clipping onto tag rails
- Individual laser-quality printing according to specifications

For custom printing: Please send us a file of our labeling software M-Print PRO or M-Print PRO Online (without installation) for your labeling specifications.

General ordering data

Type	ESG 6/15 SDI MC SDR	Version	
Order No.	2558310000	ESG, Device markers x 15 mm, PA 66, Colour: To customer specification, pluggable	
GTIN (EAN)	4050118569025		
Qty.	40 ST		

ESG 6/15



Guaranteed long service life: ESG

The multi-colour and multi-format labels have a strong adhesive layer to ensure the best possible adhesion to the underlying surface. Double laminated polyester makes the basic material very thin and yet extremely tear-resistant.

Your benefits with MultiMark

- "Different materials for various requirements"
- Can be used with equipment from many manufacturers
- Device markers with a familiar design

General ordering data

Type	ESG 6/15 MM WS	Version	
Order No.	2619940000	ESG, Device markers, 6 x 15 mm, white	
GTIN (EAN)	4050118626148		
Qty.	3000 ST		

Sockets



Relay sockets for the D-SERIES DRI relays

- 1 and 2 CO contacts
- Screw and PUSH IN connection
- Standard and low heights

General ordering data

Type	SDI 2CO	Version
Order No.	7760056351	D-SERIES DRI, Relay socket, Number of contacts: 2, CO contact,
GTIN (EAN)	6944 169739989	Continuous current: 8 A, Screw connection
Qty.	10 ST	
Type	SDI 2CO ECO	Version
Order No.	7760056347	D-SERIES DRI, Relay socket, Number of contacts: 2, CO contact,
GTIN (EAN)	6944 169739941	Continuous current: 8 A, Screw connection
Qty.	10 ST	
Type	SDI 2CO F ECO	Version
Order No.	7760056349	D-SERIES DRI, Relay socket, Number of contacts: 2, CO contact,
GTIN (EAN)	6944 169739965	Continuous current: 8 A, Screw connection
Qty.	10 ST	
Type	SDI 2CO P	Version
Order No.	7760056365	D-SERIES DRI, Relay socket, Number of contacts: 2, CO contact,
GTIN (EAN)	6944 169772290	Continuous current: 8 A, PUSH IN
Qty.	20 ST	