

Housing INOX cable connector M23 Signal

Item number 714150000

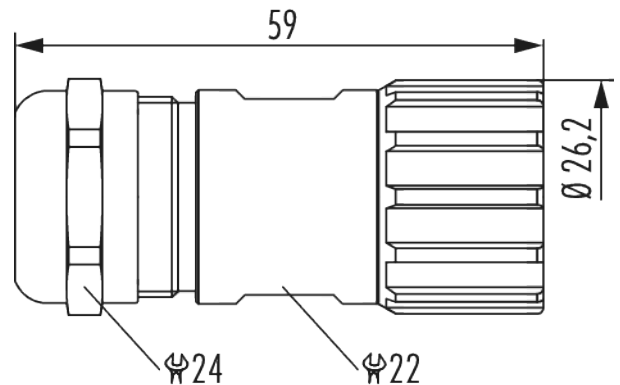

Technical data

Housing type	Cable
Material housing	Stainless steel 1.4404 (AISI 316)
Material housing surface	-
Insert	Socket
Version	Screw
External thread plug-in side	-
Internal thread plug-in side	M23 x 1
Knurled nut-Ø plug-in side	26.2 mm
Locking type	Screw
Shield	shielded
Seal type	O-Ring
Material seals/o-rings	FKM (FPM)
Wrench size (SW1/SW2)	24/22 mm
Cable diameter	7 - 12 mm
Temperature range	-40°C to +125°C
Protection class	IP 67 , IP 69 K

Housing INOX cable connector M23 Signal

Item number 714150000

Commercial data

Packaging Unit	5
EAN code	4033878502983
Weight	0.075 kg
ETIM 7	EC003556
ETIM 8	EC003556
ETIM 9	EC003556
eCl@ss 10.1	27440224
Customs tariff number	85366990

Note:

