

AFS 4 2C 10-36V DL BK**Weidmüller Interface GmbH & Co. KG**Klingenbergstraße 26
D-32758 Detmold
Germany

www.weidmueller.com

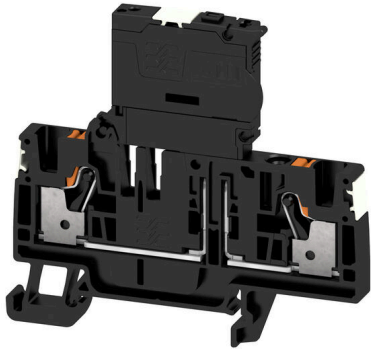

Fuse terminal blocks and component terminal blocks allow protective and functional elements to be integrated directly into the terminal strip. Fuse terminal blocks include built-in fuse holders to reliably protect electrical circuits against overload –ideal for control and distribution systems. Component terminal blocks make it possible to incorporate electronic components such as diodes, resistors, or LEDs directly into the wiring. This enables space-saving and clearly arranged implementation of switching functions and signal separation. Both types of terminal blocks ensure higher safety, easy maintenance, and a compact, function-oriented installation.

General ordering data

Version	Fuse terminal, PUSH IN, 4 mm ² , 36 V, 6.3 A, black
Order No.	2675260000
Type	AFS 4 2C 10-36V DL BK
GTIN (EAN)	4050118733471
Qty.	50 items

AFS 4 2C 10-36V DL BK

Weidmüller Interface GmbH & Co. KG
Klingenbergstraße 26
D-32758 Detmold
Germany

www.weidmueller.com

Technical data

Approvals

Approvals



ROHS Conform

Dimensions and weights

Depth	68 mm	Depth (inches)	2.6772 inch
Depth including DIN rail	69 mm	Height	74 mm
Height (inches)	2.9134 inch	Width	6.1 mm
Width (inches)	0.2402 inch	Net weight	18.87 g

Temperatures

Storage temperature	-25 °C...55 °C	Ambient temperature	-5 °C...40 °C
Continuous operating temp., min.	-60 °C	Continuous operating temp., max.	130 °C

Environmental Product Compliance

RoHS Compliance Status	Compliant without exemption
REACH SVHC	No SVHC above 0.1 wt%

Material data

Basic material	Wemid	Colour	black
UL 94 flammability rating	V-0		

Rating data IECEX/ATEX

Certificate No. (ATEX)	TUEV17ATEX8064U	Certificate No. (IECEX)	IECEXTUR17.0030U
Current (ATEX)	6.3 A	Wire cross section max. (ATEX)	4 mm ²
Current (IECEX)	6.3 A	Wire cross section max. (IECEX)	4 mm ²

System specifications

End cover plate required	Yes	Number of potentials	1
Number of levels	1	Number of potentials per tier	1
Levels cross-connected internally	Yes	Mounting rail	TS 35
N-function	No	PE function	No
PEN function	No		

Additional technical data

Open sides	right	Type of mounting	TS 35
------------	-------	------------------	-------

Conductors for clamping (additional connection)

Connection type, additional connection PUSH IN

Conductors for clamping (rated connection)

Gauge to IEC 60947-1	A4
Wire connection cross section AWG, max.	AWG 12

AFS 4 2C 10-36V DL BK

Weidmüller Interface GmbH & Co. KG
 Klingenbergstraße 26
 D-32758 Detmold
 Germany

www.weidmueller.com

Technical data

Connection direction	top		
Stripping length	12 mm		
Type of connection 2	PUSH IN		
Type of connection	PUSH IN		
Number of connections	2		
Clamping range, max.	6 mm ²		
Clamping range, min.	0.14 mm ²		
Blade size	0.6 x 3.5 mm		
Wire connection cross section AWG, min.	AWG 26		
Wire connection cross-section, finely stranded with wire-end ferrules DIN 46228/4, max.	4 mm ²		
Wire connection cross-section, finely stranded with wire-end ferrules DIN 46228/4, min.	0.14 mm ²		
Wire connection cross-section, finely stranded with wire-end ferrules DIN 46228/1, max.	6 mm ²		
Wire connection cross-section, finely stranded with wire-end ferrules DIN 46228/1, min.	0.14 mm ²		
Wire connection cross section, finely stranded, max.	6 mm ²		
Wire connection cross section, finely stranded, min.	0.14 mm ²		
Connection cross-section, stranded, max.	6 mm ²		
Connection cross-section, stranded, min.	0.14 mm ²		
Twin wire-end ferrules, max.	1.5 mm ²		
Twin wire-end ferrules, min.	0.5 mm ²		
Wire connection cross-section, solid core, max.	4 mm ²		
Wire connection cross-section, solid core, min.	0.14 mm ²		
Connection cross-section, finely stranded, min.	0.14 mm ²		
Tube length for wire-end ferrule with plastic collar DIN 46228/4	Tube length	min.	6 mm
		max.	12 mm
	Cross-section for conductor connection	min.	0.5 mm ²
		max.	1 mm ²
	Tube length	min.	8 mm
		max.	12 mm
Cross-section for conductor connection	min.	1.5 mm ²	
	max.	2.5 mm ²	
Tube length for twin wire-end ferrule	Tube length	min.	8 mm
		max.	12 mm
	Cross-section for conductor connection	min.	0.5 mm ²
		max.	1.5 mm ²
	Tube length	min.	10 mm
		max.	12 mm
Cross-section for conductor connection	nominal	4 mm ²	
Tube length for wire-end ferrule without plastic collar DIN 46228/1	Tube length	min.	6 mm
		max.	10 mm
	Cross-section for conductor connection	min.	0.5 mm ²
		max.	1 mm ²
	Tube length	min.	7 mm
		max.	12 mm
Cross-section for conductor connection	min.	1.5 mm ²	
	max.	2.5 mm ²	

AFS 4 2C 10-36V DL BK

Weidmüller Interface GmbH & Co. KG
 Klingenbergstraße 26
 D-32758 Detmold
 Germany

www.weidmueller.com

Technical data

Tube length	min.	9 mm
	max.	15 mm
Cross-section for conductor connection	min.	4 mm ²
	max.	6 mm ²

Fuse terminals

Cartridge fuse	G-Si. 5 x 20	Fuse holder (cartridge holder)	Pivoting
Type of voltage for indicator	AC/DC	Leakage current, max.	0.5 mA

General

Wire connection cross section AWG, max.	AWG 12	Wire connection cross section AWG, min.	AWG 26
Standards	DIN EN 60947-7-3	Mounting rail	TS 35

Rating data

Rated cross-section	4 mm ²	Rated voltage	36 V
Rated DC voltage	36 V	Nominal current	6.3 A
Current at maximum wires	6.3 A	Standards	DIN EN 60947-7-3
Volume resistance according to IEC 60947-7-x	1 mΩ	Rated impulse withstand voltage	4 kV
Power loss in accordance with IEC 60947-7-x	1.02 W	Surge voltage category	III
Pollution severity	3		

Classifications

ETIM 8.0	EC000899	ETIM 9.0	EC000899
ETIM 10.0	EC000899	ECLASS 14.0	27-25-01-13
ECLASS 15.0	27-25-01-13		

Drawings

