

ACT20P-PRO-RTCI-AO-DO-S

Weidmüller Interface GmbH & Co. KG
 Klingenbergstraße 26
 D-32758 Detmold
 Germany

www.weidmueller.com



ACT20P: The flexible solution

- Precise and highly functional signal converters
- Release levers simplify handling

General ordering data

Version	Temperature converter, Limit value monitoring, Input : Temperature, Resistance, Potentiometer, Output : I/U universal, Transistor (Alarm)
Order No.	2448100000
Type	ACT20P-PRO-RTCI-AO-DO-S
GTIN (EAN)	4050118462241
Qty.	1 items

ACT20P-PRO-RTCI-AO-DO-S

Weidmüller Interface GmbH & Co. KG
 Klingenbergstraße 26
 D-32758 Detmold
 Germany

www.weidmueller.com

Technical data

Approvals

Approvals



ROHS	Conform
UL File Number Search	UL Website
Certificate no. (cULus)	E337701

Dimensions and weights

Depth	113.7 mm	Depth (inches)	4.4764 inch
Height	119.2 mm	Height (inches)	4.6929 inch
Width	12.5 mm	Width (inches)	0.4921 inch
Net weight	194 g		

Temperatures

Storage temperature	-40 °C...85 °C	Operating temperature	-40 °C...60 °C
Humidity	5...95 %, no condensation		

Probability of failure

MTTF	20 a
------	------

Environmental Product Compliance

RoHS Compliance Status	Compliant with exemption
RoHS Exemption (if applicable/known)	7a, 7cl
REACH SVHC	Lead 7439-92-1
SCIP	2f6dd957-42 1a-46db-a0c2-cf1609156924

Input

Sensor	RTD: PT100, PT200, PT500, PT1000, Ni50, Ni100, Ni120, Ni1000, Cu10, Cu25, Cu50, Cu100, RTD (2-wire): KTY83/110, KTY83/120, KTY83/150, KTY83/121, KTY83/122, KTY83/210, KTY83/220, KTY83/221, KTY83/250, KTY82/110, KTY82/120, KTY82/150, KTY82/121, KTY82/122, KTY82/210, KTY82/220, KTY82/221, KTY82/250, KTY84/130, KTY16, KTY19, ST13, ST20, Thermocouples: B, E, J, K, L, N, R, S, T,U, L	Number inputs	1
Potentiometer	500 Ω... 120 kΩ	Input voltage	0...300 mV
Temperature input range	adjustible from -200...+850 °C	Resistance	0... 15 kΩ
Note, technical data 1	see details in instruction sheet		

ACT20P-PRO-RTCI-AO-DO-S

Weidmüller Interface GmbH & Co. KG
 Klingenbergstraße 26
 D-32758 Detmold
 Germany

www.weidmueller.com

Technical data

Output (digital)

Rated switching voltage	24 VDC $\pm 30\%$	Rated switching current	100 mA
Number of digital outputs	1	Hysteresis	1...20 %
Type	NPN-Transistor	Switch-on delay	0...180 s, 50 ms ... 7.5 s
Alarm function	configurable, Top and bottom limit values, window range, Short circuit at input		

Output (analogue)

Signal output	direct or inverted	Type (analogue output)	Voltage and current output (configurable), Active/passive
Transmit function	linear, \sqrt{X} , X1, X1.5, X2, X2.5, 1-X, -5...+5 % of output span (TRIM)	Output voltage	configurable, 0(1)...5 V, 0(2)...10 V, downscale (0 V), upscale (11 V), -5...+5 V, -10...+10 V
Load resistance voltage	> 1 k Ω (60 VAC <U _{in} <230 VAC), > 5 k Ω (24 VAC <U _{in} <60 VAC)	Number analogue outputs	1
Load resistance current	$\leq 600 \Omega$	Output current	configurable, 0(4)...20 mA, -20...+20 mA, ± 10 mA, upscale (23 mA), downscale (3,5 mA)

Display

Display range	-9999...9999, -999...9999	Display value	Configuration data and process data (input/output) in operation
Type	Dot-matrix display with ticker text, green		

General data

Accuracy	Basic accuracy: $\leq 0.05\%$ of span, Accuracy of the individual sensor types, see instruction sheet.	Protection degree	IP20
Supply voltage	24...230 V DC $\pm 15\%$, 110 - 230 V AC / 60-50 Hz	Long-term drift	0.1 % / 10.000 h
Step response time	10 ms, 2- / 4- wire: 320 ms; 3- wire / Poti: 640 ms	Mounting rail	TS 35
Power consumption	≤ 2.5 W	Temperature coefficient	$\pm 0.01\%$ of output span / $^{\circ}\text{C}$
Nominal power consumption	3 VA	Configuration	with push-buttons and display
Operating altitude	≤ 2000 m	Included in delivery	Transducer, Instruction sheet

Insulation coordination

Impulse withstand voltage	5 kV (1.2/50 μs)	EMC standards	EN 61326-1
Surge voltage category	II	Pollution severity	2
Galvanic isolation	4-way isolator, between input / output / supply	Insulation voltage	4 kV _{eff} / 1 min.
Rated voltage	600 V		

ACT20P-PRO-RTCI-AO-DO-S

Weidmüller Interface GmbH & Co. KG
 Klingenbergstraße 26
 D-32758 Detmold
 Germany

www.weidmueller.com

Technical data

Data for Ex applications (ATEX)

IECEx - gas labelling Ex ec IIC T4 Gc

Connection data

Type of connection	Screw connection	Tightening torque, min.	0.4 Nm
Tightening torque, max.	0.6 Nm	Clamping range, rated connection	2.5 mm ²
Clamping range, min.	0.5 mm ²	Clamping range, max.	2.5 mm ²
Wire connection cross section AWG, min.	AWG 26	Wire connection cross section AWG, max.	AWG 12
Wire cross-section, solid, min.	0.2 mm ²	Wire cross-section, solid, max.	2.5 mm ²
Wire connection cross section, finely stranded, min.	0.2 mm ²	Wire connection cross-section, finely stranded with wire-end ferrules DIN 46228/4, min.	0.2 mm ²
Wire connection cross-section, finely stranded with wire-end ferrules DIN 46228/4, max.	2.5 mm ²		

Part description

Product description The universal, configurable resistance measuring transducer ACT20P-PRO-RTCI-AO-DOS converts 2- / 3- / 4-wire ohmic resistance and potentiometers into an active or passive standard current signal or an active voltage signal. For set point Limit Monitoring the device is equipped with an digital NPN Output. The universal power supply can be powered up from 24Vuc...230Vuc. The device can be configured via the display.

Features

- universal wide range supply
- universal configurability, LED- Display by touch key
- Active or passive signal output
- Digital NPN transistor output
- Operating status display via front-sided LED
- Galvanic 4-way isolation between Input, analogue, digital output and supply

Classifications

ETIM 8.0	EC002919	ETIM 9.0	EC002919
ETIM 10.0	EC002919	ECLASS 14.0	27-21-01-29
ECLASS 15.0	27-21-01-29		

ACT20P-PRO-RTCI-AO-DO-S

Weidmüller Interface GmbH & Co. KG
 Klingenbergstraße 26
 D-32758 Detmold
 Germany

Drawings

www.weidmueller.com

Connection diagram

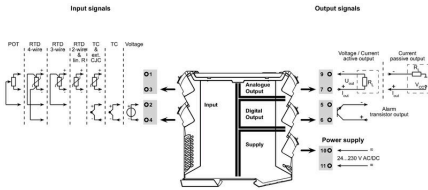

Dimensioned drawing

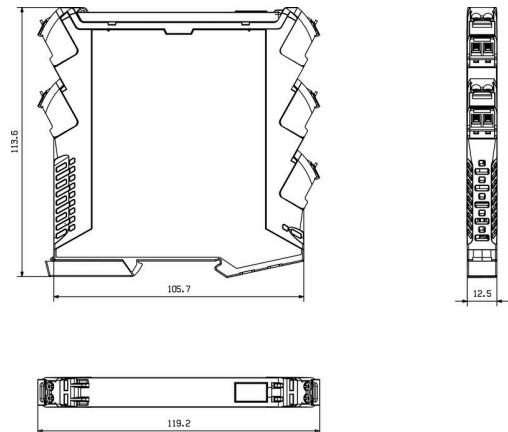

Flow diagram part

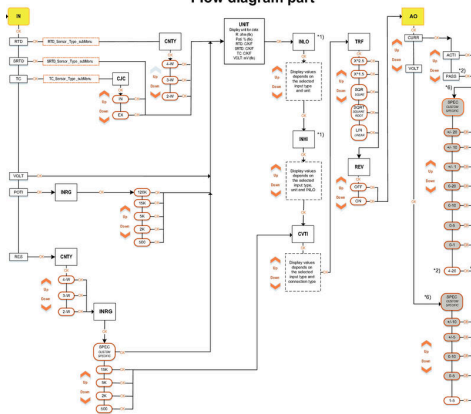

Measuring overrange

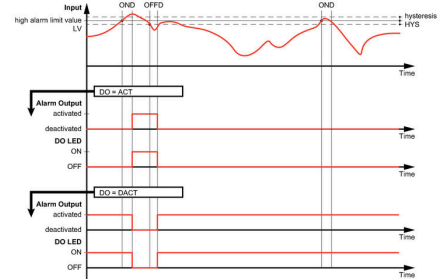

ACT20P-PRO-RTCI-AO-DO-S

Weidmüller Interface GmbH & Co. KG
 Klingenbergstraße 26
 D-32758 Detmold
 Germany

Drawings

www.weidmueller.com

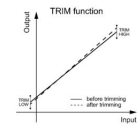
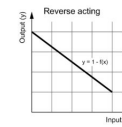
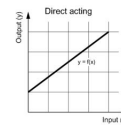
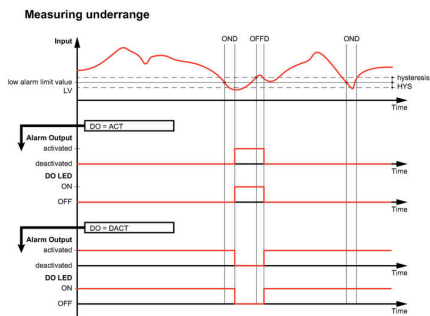

ACT20P-PRO-RTCI-AO-DO-S

Weidmüller Interface GmbH & Co. KG
 Klingenbergstraße 26
 D-32758 Detmold
 Germany

www.weidmueller.com

Accessories

Blank



ESG is the tried-and-tested marker in MultiCard format for use on many well-known electrical devices. The result is high-quality device marking with a high-contrast appearance.

Various types are available for devices from manufacturers like Siemens, ABB, Beckhoff etc.

Advantages at a glance:

- Tags for universal usage, self-adhesive or clip-on tags, depending on type
- For aligned equipment, e.g. circuit breakers, we supply ESG markers for clipping onto tag rails
- Individual laser-quality printing according to specifications

For custom printing: Please send us a file of our labeling software M-Print PRO or M-Print PRO Online (without installation) for your labeling specifications.

General ordering data

Type	ESG 8/13.5/43.3 SAI AU	Version
Order No.	1912130000	ESG, Device markers x 13.5 mm, PA 66, Colour: Transparent, pluggable
GTIN (EAN)	4032248541164	
Qty.	5 ST	
Type	ESG 6.6/11 BHZ 5.00/02	Version
Order No.	1082490000	ESG, Device markers x 11 mm, PA 66, Colour: white, pluggable
GTIN (EAN)	4032248845330	
Qty.	200 ST	