

BL 3.50/04/180LH SN OR BX

Weidmüller Interface GmbH & Co. KG
 Klingenbergstraße 26
 D-32758 Detmold
 Germany

www.weidmueller.com

Product image

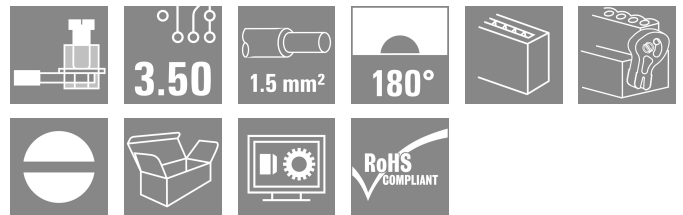

Female connectors with clamping yoke screw system for connecting conductors at 3.50 mm pitch. They provide space for labelling and can be coded.

General ordering data

Version	PCB plug-in connector, female plug, 3.50 mm, Number of poles: 4, 180°, Clamping yoke connection, Clamping range, max. : 1.5 mm ² , Box
Order No.	1687670000
Type	BL 3.50/04/180LH SN OR BX
GTIN (EAN)	4008190853228
Qty.	84 items
Product data	IEC: 320 V / 17 A / 0.2 - 1.5 mm ² UL: 300 V / 10 A / AWG 28 - AWG 14
Packaging	Box

BL 3.50/04/180LH SN OR BX

Weidmüller Interface GmbH & Co. KG
 Klingenbergstraße 26
 D-32758 Detmold
 Germany

www.weidmueller.com

Technical data

Approvals

Approvals



ROHS	Conform
UL File Number Search	UL Website
Certificate No. (UR)	E60693

Dimensions and weights

Depth	29.5 mm	Depth (inches)	1.1614 inch
Height	14.9 mm	Height (inches)	0.5866 inch
Width	20.5 mm	Width (inches)	0.8071 inch
Net weight	4.57 g		

Environmental Product Compliance

RoHS Compliance Status	Compliant without exemption		
REACH SVHC	No SVHC above 0.1 wt%		
Product Carbon Footprint	Cradle to gate	0,265 kg CO2 eq.	

System Parameters

Product family	OMNIMATE Signal - series BL/SL 3.50		
Type of connection	Field connection		
Wire connection method	Clamping yoke connection		
Pitch in mm (P)	3.50 mm		
Pitch in inches (P)	0.138 "		
Conductor outlet direction	180°		
Number of poles	4		
L1 in mm	10.50 mm		
L1 in inches	0.413 "		
Number of rows	1		
Pin series quantity	1		
Rated cross-section	1.5 mm ²		
Touch-safe protection acc. to DIN VDE 57 106	Safe from finger touch		
Touch-safe protection acc. to DIN VDE 0470	IP20 plugged/ IP10 unplugged		
Protection degree	IP20, when fully mounted		
Volume resistance	≤5 mΩ		
Can be coded	Yes		
Stripping length	6 mm		
Clamping screw	M 2		
Screwdriver blade	0.4 x 2.5		
Screwdriver blade standard	DIN 5264		
Plugging cycles	25		
Plugging force/pole, max.	7 N		
Pulling force/pole, max.	5 N		
Tightening torque	Torque type	Wire connection	
	Usage information	Tightening torque	min. 0.2 Nm max. 0.25 Nm

BL 3.50/04/180LH SN OR BX

Weidmüller Interface GmbH & Co. KG
 Klingenbergstraße 26
 D-32758 Detmold
 Germany

www.weidmueller.com

Technical data

Material data

Insulating material	PBT	Colour	orange
Colour chart (similar)	RAL 2000	Insulating material group	Illa
Comparative Tracking Index (CTI)	≥ 200	Moisture Level (MSL)	
UL 94 flammability rating	V-0	Contact material	Cu-alloy
Contact surface	tinned	Layer structure of plug contact	4...8 µm Sn hot-dip tinned
Storage temperature, min.	-40 °C	Storage temperature, max.	70 °C
Operating temperature, min.	-50 °C	Operating temperature, max.	100 °C
Temperature range, installation, min.	-30 °C	Temperature range, installation, max.	100 °C

Conductors suitable for connection

Clamping range, min.	0.08 mm ²
Clamping range, max.	1.5 mm ²
Wire connection cross section AWG, min.	AWG 28
Wire connection cross section AWG, max.	AWG 14
Solid, min. H05(07) V-U	0.2 mm ²
Solid, max. H05(07) V-U	1.5 mm ²
Flexible, min. H05(07) V-K	0.2 mm ²
Flexible, max. H05(07) V-K	1.5 mm ²
w. plastic collar ferrule, DIN 46228 pt 4, 0.2 mm ² min.	
w. plastic collar ferrule, DIN 46228 pt 4, 1.5 mm ² max.	
w. wire end ferrule, DIN 46228 pt 1, min.	0.2 mm ²
w. wire end ferrule, DIN 46228 pt 1, max.	1.5 mm ²
Plug gauge in accordance with EN 60999 a x b; ø	2.4 mm x 1.5 mm

Clampable conductor	Cross-section for conductor connection	Type	fine-wired
		nominal	0.5 mm ²
wire end ferrule	wire end ferrule	Stripping length	nominal 8 mm
		Recommended wire-end ferrule	H0.5/12 OR
		Stripping length	nominal 6 mm
		Recommended wire-end ferrule	H0.5/6
Cross-section for conductor connection	Cross-section for conductor connection	Type	fine-wired
		nominal	0.75 mm ²
wire end ferrule	wire end ferrule	Stripping length	nominal 8 mm
		Recommended wire-end ferrule	H0.75/12 W
		Stripping length	nominal 6 mm
		Recommended wire-end ferrule	H0.75/6
Cross-section for conductor connection	Cross-section for conductor connection	Type	fine-wired
		nominal	1 mm ²
wire end ferrule	wire end ferrule	Stripping length	nominal 8 mm
		Recommended wire-end ferrule	H1.0/12 GE
		Stripping length	nominal 6 mm
		Recommended wire-end ferrule	H1.0/6
Cross-section for conductor connection	Cross-section for conductor connection	Type	fine-wired
		nominal	0.25 mm ²
wire end ferrule	wire end ferrule	Stripping length	nominal 8 mm

BL 3.50/04/180LH SN OR BX

Weidmüller Interface GmbH & Co. KG
 Klingenbergstraße 26
 D-32758 Detmold
 Germany

www.weidmueller.com

Technical data

		Recommended wire-end ferrule	HO,25/10 HBL
		Stripping length	nominal 5 mm
		Recommended wire-end ferrule	HO,25/5
	Cross-section for conductor connection	Type	fine-wired
		nominal	0.34 mm ²
	wire end ferrule	Stripping length	nominal 8 mm
		Recommended wire-end ferrule	HO,34/10 TK
Reference text	The outside diameter of the plastic collar should not be larger than the pitch (P), Length of ferrules is to be chosen depending on the product and the rated voltage.		

Rated data acc. to IEC

tested acc. to standard	IEC 60664-1, IEC 61984	Rated current, min. number of poles (Tu=20°C)	17 A
Rated current, max. number of poles (Tu=20°C)	12 A	Rated current, min. number of poles (Tu=40°C)	14.5 A
Rated current, max. number of poles (Tu=40°C)	10 A	Rated voltage for surge voltage class / pollution degree II/2	320 V
Rated voltage for surge voltage class / pollution degree III/2	160 V	Rated voltage for surge voltage class / pollution degree III/3	160 V
Rated impulse voltage for surge voltage class/ pollution degree II/2	320 V	Rated impulse voltage for surge voltage class/ pollution degree III/2	160 V
Rated impulse voltage for surge voltage class/ contamination degree III/3	160 V	Short-time withstand current resistance	3 x 1s with 100 A

Rated data acc. to CSA

Rated voltage (Use group B / CSA)	300 V	Rated voltage (Use group D / CSA)	300 V
Rated current (Use group B / CSA)	10 A	Rated current (Use group D / CSA)	10 A
Wire cross-section, AWG, min.	AWG 28	Wire cross-section, AWG, max.	AWG 14

Rated data acc. to UL 1059

Institute (UR)	UR	Certificate No. (UR)	E60693
Rated voltage (Use group B / UL 1059)	300 V	Rated voltage (Use group D / UL 1059)	300 V
Rated current (Use group B / UL 1059)	10 A	Rated current (Use group D / UL 1059)	10 A
Wire cross-section, AWG, min.	AWG 28	Wire cross-section, AWG, max.	AWG 14
Reference to approval values	Specifications are maximum values, details - see approval certificate.		

Packing

Packaging	Box	VPE length	351.00 mm
VPE width	136.00 mm	VPE height	25.00 mm

Type tests

Test: Durability of markings	Standard	DIN EN 61984 section 7.3.2 / 09.02 taking pattern from DIN EN 60068-2-70 / 07.96
	Test	mark of origin, type identification, approval marking SEV, approval marking CSA
	Evaluation	available
	Test	durability
	Evaluation	passed
Test: Misengagement (Non-interchangeability)	Standard	DIN EN 61984 section 6.3 and 6.9.1 / 09.02, DIN IEC 60512 part 7 section 5 / 05.94

Technical data

	Test	180° turned with coding elements	
	Evaluation	passed	
Test: Clampable cross section	Standard	DIN EN 60999-1 section 7 and 9.1 / 12.00, DIN EN 60947-1 section 8.2.4.5.1 / 12.99	
	Conductor type	Type of conductor and conductor cross-section	solid 0.2 mm ²
		Type of conductor and conductor cross-section	stranded 0.2 mm ²
		Type of conductor and conductor cross-section	solid 1.5 mm ²
		Type of conductor and conductor cross-section	stranded 1.5 mm ²
		Type of conductor and conductor cross-section	AWG 28/1
		Type of conductor and conductor cross-section	AWG 28/19
		Type of conductor and conductor cross-section	AWG 16/1
		Type of conductor and conductor cross-section	AWG 16/19
	Evaluation	passed	
Test for damage to and accidental loosening of conductors	Standard	DIN EN 60999-1 section 9.4 / 12.00	
	Requirement	0.2 kg	
	Conductor type	Type of conductor and conductor cross-section	AWG 28/1
		Type of conductor and conductor cross-section	AWG 28/19
	Evaluation	passed	
	Requirement	0.3 kg	
	Conductor type	Type of conductor and conductor cross-section	2 × AWG 24/1
		Type of conductor and conductor cross-section	2 × AWG 24/19 with wire end ferrule
	Evaluation	passed	
	Requirement	0.4 kg	
Conductor type	Type of conductor and conductor cross-section	solid 1.5 mm ²	
	Type of conductor and conductor cross-section	stranded 1.5 mm ²	
	Type of conductor and conductor cross-section	AWG 16/7	
Evaluation	passed		
Pull-out test	Standard	DIN EN 60999-1 section 9.5 / 12.00	
	Requirement	≥5 N	
	Conductor type	Type of conductor and conductor cross-section	AWG 28/1

Technical data

	Type of conductor and conductor cross-section	AWG 28/19
Evaluation	passed	
Requirement	≥10 N	
Conductor type	Type of conductor and conductor cross-section	2 × AWG 24/1
	Type of conductor and conductor cross-section	2 × AWG 24/19 with wire end ferrule
Evaluation	passed	
Requirement	≥40 N	
Conductor type	Type of conductor and conductor cross-section	H05V-U1.5
	Type of conductor and conductor cross-section	H05V-K1.5
	Type of conductor and conductor cross-section	AWG 16/7
Evaluation	passed	

Important note

IPC conformity Conformity: The products are developed, manufactured and delivered according international recognized standards and norms and comply with the assured properties in the data sheet resp. fulfill decorative properties in accordance with IPC-A-610 "Class 2". Further claims on the products can be evaluated on request.

- Notes**
- Additional variants on request
 - Gold-plated contact surfaces on request
 - Rated current related to rated cross-section & min. No. of poles.
 - Max. outer diameter of the conductor: 2.9 mm
 - Wire end ferrule without plastic collar to DIN 46228/1
 - Wire end ferrule with plastic collar to DIN 46228/4
 - P on drawing = pitch
 - Rated data refer only to the component itself. Clearance and creepage distances to other components are to be designed in accordance with the relevant application standards.
 - In accordance with IEC 61984, OMNIMATE-connectors are connectors without breaking capacity (COC). During designated use, connectors are not allowed to be engaged or disengaged when live or under load
 - Long term storage of the product with average temperature of 50 °C and maximum humidity 70%, 36 months

Classifications

ETIM 8.0	EC002638	ETIM 9.0	EC002638
ETIM 10.0	EC002638	ECLASS 14.0	27-46-02-02
ECLASS 15.0	27-46-02-02		

BL 3.50/04/180LH SN OR BX

Weidmüller Interface GmbH & Co. KG
 Klingenbergstraße 26
 D-32758 Detmold
 Germany

www.weidmueller.com

Drawings

Product image

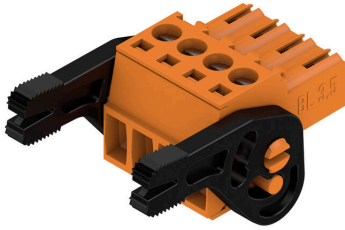

Dimensional drawing

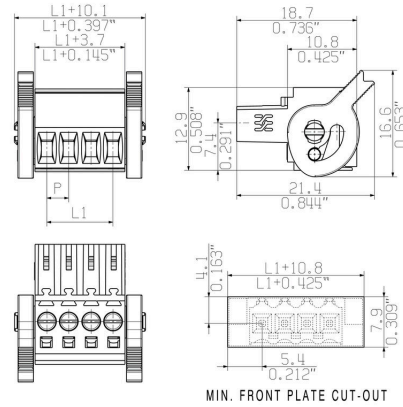

Graph

BL 3.50/./180 - SL-SMT 3.50/./90

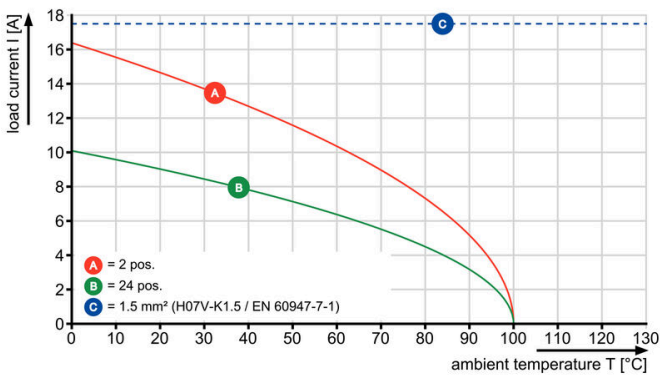

Graph

BL 3.50/./180 - SLD 3.50/./90

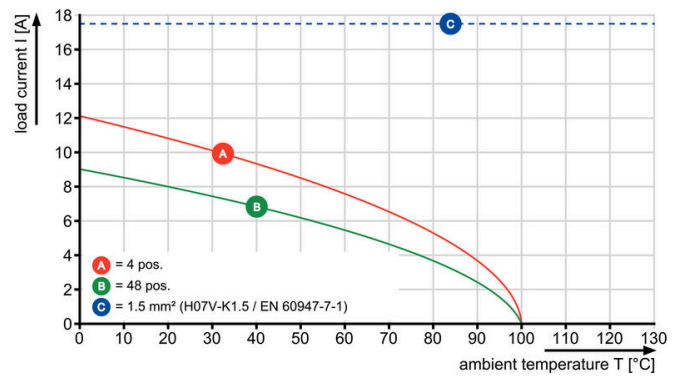

Graph

BL 3.50/./180 - SLD 3.50V/./180

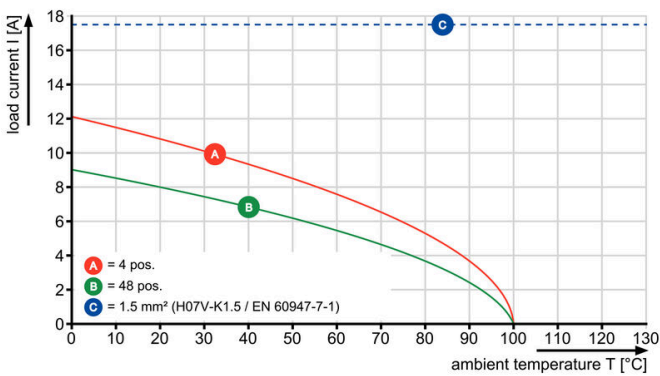

Graph

BL 3.50/./180 - SL 3.50/./90

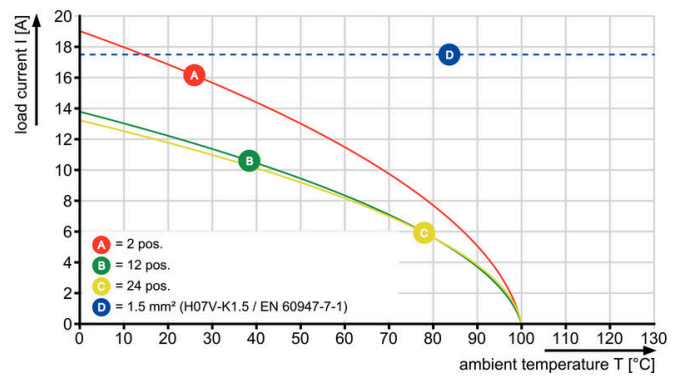

BL 3.50/04/180LH SN OR BX

Weidmüller Interface GmbH & Co. KG
 Klingenbergstraße 26
 D-32758 Detmold
 Germany

www.weidmueller.com

Accessories

Strain reliefs



For frequent load changes: the "trailer coupling" for plug-in connectors.

The strain relief can do more than just relieve the strain on conductors:

Simply clip onto the plug and

- bundle conductors
- guide cables
- use as a connection and disconnection aid

No damage to the connecting points, clear, tidy wiring and easy to handle.

User advantages: permanent heavy-duty connections for harsh industrial environments and convenient operation ensure improved system availability.

General ordering data

Type	BL 3.50 ZE03 BK BX	Version
Order No.	1627820000	PCB plug-in connector, Accessories, Strain relief, black, Number of
GTIN (EAN)	4008190202552	poles: 3
Qty.	50 ST	
Type	BL 3.50 ZE03 OR BX	Version
Order No.	1629680000	PCB plug-in connector, Accessories, Strain relief, orange, Number of
GTIN (EAN)	4008190202569	poles: 3
Qty.	50 ST	

Coding elements

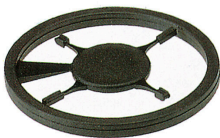

Only connects what is supposed to be connected: the right connection at the right place.

Coding elements and locking devices clearly assign connecting elements during the manufacturing process and operation

The coding elements and locking devices are inserted prior to assembly or during the cable assembly phase.

The Weidmüller alternative: configure online using the variant configurator to precode prior to delivery.

Incorrect assembly on the circuit board and incorrect plugging of connecting elements is no longer possible.

The advantage: no troubleshooting during manufacture and no operational errors by the user.

General ordering data

Type	BL SL 3.5 KO OR	Version
Order No.	1693430000	PCB plug-in connector, Accessories, Coding element, orange, Number
GTIN (EAN)	4008190867447	of poles: 1
Qty.	100 ST	

BL 3.50/04/180LH SN OR BX

Weidmüller Interface GmbH & Co. KG
 Klingenbergstraße 26
 D-32758 Detmold
 Germany

www.weidmueller.com

Accessories

Cover hoods



Effective protection, optimised ergonomics and closed design:

From the strain relief on the connected conductors and the visual/contact protection and the disconnection aid: the optional retrofit hoods perform mechanical, visual and haptic functions.

The two half shells clip together securely, enclose the plug completely and offer the following functions:

- Cable ties or integrated cable clips provide strain relief.
- Marked with dekafix labels or adhesive strips
- Mounting side by side without losing poles or displacing the pitch
- Compatible: suitable for plugs with or without a flange or mounting bracket
- Flexible: 1-3 cable outlets leading in different directions available depending on the size

Weidmüller hoods offer added stability, better

identification, complete compatibility and versatility.

The result: maximum reliability and user-friendliness in any application.

General ordering data

Type	BL 3.50 AH04 BK BX	Version	
Order No.	1745590000	PCB plug-in connector, Accessories, Hood, black, Number of poles: 4	
GTIN (EAN)	4008190985158		
Qty.	10 ST		

Coding elements



Only connects what is supposed to be connected: the right connection at the right place.

Coding elements and locking devices clearly assign connecting elements during the manufacturing process and operation

The coding elements and locking devices are inserted prior to assembly or during the cable assembly phase.

The Weidmüller alternative: configure online using the variant configurator to precode prior to delivery.

Incorrect assembly on the circuit board and incorrect plugging of connecting elements is no longer possible.

The advantage: no troubleshooting during manufacture and no operational errors by the user.

General ordering data

Type	BL SL 3.5 KO SW	Version	
Order No.	1610100000	PCB plug-in connector, Accessories, Coding element, black, Number of poles: 1	
GTIN (EAN)	4008190187637		
Qty.	100 ST		

BL 3.50/04/180LH SN OR BX

Weidmüller Interface GmbH & Co. KG
 Klingenbergstraße 26
 D-32758 Detmold
 Germany

www.weidmueller.com

Counterpart

SLD 3.50/90

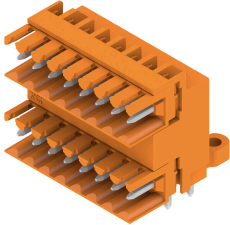

Two-tier pin header for wave soldering in 3.50 mm pitch. The connector is available in open, closed and flange versions. The male connectors provide space for labelling and can be coded. Packed in a cardboard box.

General ordering data

Type	SLD 3.50/08/90 3.2SN OR...	Version
Order No.	1633370000	PCB plug-in connector, male header, open side, THT solder
GTIN (EAN)	4008190257828	connection, 3.50 mm, Number of poles: 8, 90°, Solder pin length (l):
Qty.	50 ST	3.2 mm, tinned, orange, Box

SLD 3.50/90G

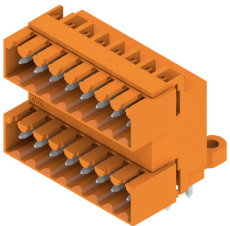

Two-tier pin header for wave soldering in 3.50 mm pitch. The connector is available in open, closed and flange versions. The male connectors provide space for labelling and can be coded. Packed in a cardboard box.

General ordering data

Type	SLD 3.50/08/90G 3.2SN O...	Version
Order No.	1633600000	PCB plug-in connector, male header, closed side, THT solder
GTIN (EAN)	4008190258054	connection, 3.50 mm, Number of poles: 8, 90°, Solder pin length (l):
Qty.	50 ST	3.2 mm, tinned, orange, Box

SLD 3.50/90F

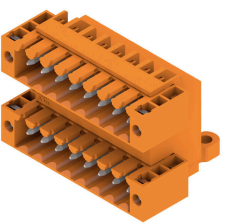

Two-tier pin header for wave soldering in 3.50 mm pitch. The connector is available in open, closed and flange versions. The male connectors provide space for labelling and can be coded. Packed in a cardboard box.

General ordering data

Type	SLD 3.50/08/90F 3.2SN O...	Version
Order No.	1633830000	PCB plug-in connector, male header, Flange, THT solder connection,
GTIN (EAN)	4008190258283	3.50 mm, Number of poles: 8, 90°, Solder pin length (l): 3.2 mm,
Qty.	50 ST	tinned, orange, Box

BL 3.50/04/180LH SN OR BX

Weidmüller Interface GmbH & Co. KG
 Klingenbergstraße 26
 D-32758 Detmold
 Germany

www.weidmueller.com

Counterpart

SLD 3.50V/180G

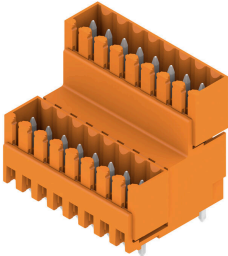

Double-level, staggered pin header for wave soldering at 3.50 mm pitch. They are available in closed and flanged versions. The male connectors provide space for labelling and can be coded.

General ordering data

Type	SLD 3.50V/08/180G 3.2SN...	Version
Order No.	1641120000	PCB plug-in connector, male header, closed side, THT solder
GTIN (EAN)	4008190279523	connection, 3.50 mm, Number of poles: 8, 180°, Solder pin length (l):
Qty.	50 ST	3.2 mm, tinned, orange, Box

SLD 3.50V/180F

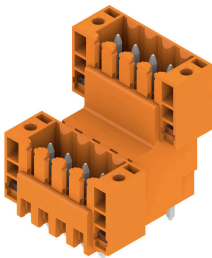

Double-level, staggered pin header for wave soldering at 3.50 mm pitch. They are available in closed and flanged versions. The male connectors provide space for labelling and can be coded.

General ordering data

Type	SLD 3.50 V/08/180F 3.2 ...	Version
Order No.	1641250000	PCB plug-in connector, male header, Flange, THT solder connection,
GTIN (EAN)	4008190279653	3.50 mm, Number of poles: 8, 180°, Solder pin length (l): 3.2 mm,
Qty.	50 ST	tinned, orange, Box

SLD 3.50V/90G

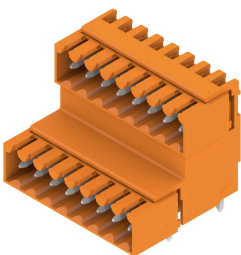

Double-level, staggered pin header for wave soldering at 3.50 mm pitch. They are available in closed and flanged versions. The male connectors provide space for labelling and can be coded.

General ordering data

Type	SLD 3.50V/08/90G 3.2SN ...	Version
Order No.	1642250000	PCB plug-in connector, male header, closed side, THT solder
GTIN (EAN)	4008190280772	connection, 3.50 mm, Number of poles: 8, 90°, Solder pin length (l):
Qty.	50 ST	3.2 mm, tinned, orange, Box

BL 3.50/04/180LH SN OR BX

Weidmüller Interface GmbH & Co. KG
 Klingenbergstraße 26
 D-32758 Detmold
 Germany

www.weidmueller.com

Counterpart

Type	SLD 3.50V/08/90G 4.5SN ...	Version
Order No.	1642870000	PCB plug-in connector, male header, closed side, THT solder
GTIN (EAN)	4008190281465	connection, 3.50 mm, Number of poles: 8, 90°, Solder pin length (l):
Qty.	50 ST	4.5 mm, tinned, black, Box

SL 3.50/135F

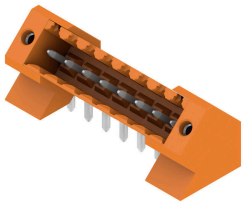

- Pin headers for wave soldering in 3.50 mm pitch
- Plugging direction is parallel (90°), straight 180° or angled (135°) to the PCB
 - Housing variant: screw flange (F)
 - Packed in a cardboard box (BX)
 - Pin header can be coded

General ordering data

Type	SL 3.50/04/135F 3.2SN O...	Version
Order No.	1643350000	PCB plug-in connector, male header, Flange, THT solder connection,
GTIN (EAN)	4008190282110	3.50 mm, Number of poles: 4, 135°, Solder pin length (l): 3.2 mm,
Qty.	84 ST	tinned, orange, Box

SL 3.50/90G

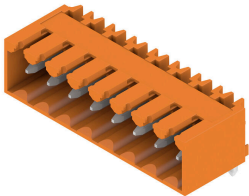

- Pin headers for wave soldering in 3.50 mm pitch
- Plugging direction is parallel (90°), straight 180° or angled (135°) to the PCB
 - Housing variant: screw flange (F)
 - Packed in a cardboard box (BX)
 - Pin header can be coded

General ordering data

Type	SL 3.50/04/90G 3.2SN BK...	Version
Order No.	1719990000	PCB plug-in connector, male header, closed side, THT solder
GTIN (EAN)	4008190354275	connection, 3.50 mm, Number of poles: 4, 90°, Solder pin length (l):
Qty.	120 ST	3.2 mm, tinned, black, Box

BL 3.50/04/180LH SN OR BX

Weidmüller Interface GmbH & Co. KG
Klingenbergstraße 26
D-32758 Detmold
Germany

www.weidmueller.com

Counterpart

SL-SMT 3.5/180G Box



- High-temperature-resistant male header, 3.50 mm pitch.
- Plugging direction parallel (90°), straight 180° or angled (135°) to PCB
 - Housing variants: closed side (G), screw flange (F), solder flange (LF) or snap-on solder flange (RF)
 - Optimised for the SMT process
 - Pin length 3.2 mm universal for all soldering methods
 - Pin length 1.5 mm optimised for reflow soldering methods
 - Packed either in a box (BX) or tape-on-reel (RL)
 - Male header can be coded

General ordering data

Type	SL-SMT 3.50/04/180G 1.5...	Version
Order No.	1753002001	PCB plug-in connector, male header, closed side, THT/THR solder
GTIN (EAN)	4032248130894	connection, 3.50 mm, Number of poles: 4, 180°, Solder pin length (l):
Qty.	100 ST	1.5 mm, tinned, black, Box

SL-SMT 3.5/90G Box



- High-temperature-resistant male header, 3.50 mm pitch.
- Plugging direction parallel (90°), straight 180° or angled (135°) to PCB
 - Housing variants: closed side (G), screw flange (F), solder flange (LF) or snap-on solder flange (RF)
 - Optimised for the SMT process
 - Pin length 3.2 mm universal for all soldering methods
 - Pin length 1.5 mm optimised for reflow soldering methods
 - Packed either in a box (BX) or tape-on-reel (RL)
 - Male header can be coded

General ordering data

Type	SL-SMT 3.50/04/90G 1.5S...	Version
Order No.	1761562001	PCB plug-in connector, male header, closed side, THT/THR solder
GTIN (EAN)	4032248132058	connection, 3.50 mm, Number of poles: 4, 90°, Solder pin length (l):
Qty.	100 ST	1.5 mm, tinned, black, Box

SL-SMT 3.5/90G Tape

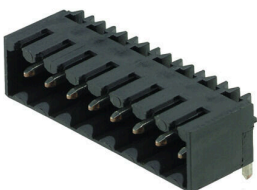

- High-temperature-resistant male header, 3.50 mm pitch.
- Plugging direction parallel (90°), straight 180° or angled (135°) to PCB
 - Housing variants: closed side (G), screw flange (F), solder flange (LF) or snap-on solder flange (RF)
 - Optimised for the SMT process
 - Pin length 3.2 mm universal for all soldering methods
 - Pin length 1.5 mm optimised for reflow soldering methods
 - Packed either in a box (BX) or tape-on-reel (RL)
 - Male header can be coded

BL 3.50/04/180LH SN OR BX

Weidmüller Interface GmbH & Co. KG
 Klingenbergstraße 26
 D-32758 Detmold
 Germany

www.weidmueller.com

Counterpart

General ordering data

Type	SL-SMT 3.50/04/90G 1.5S...	Version
Order No.	1761564001	PCB plug-in connector, male header, closed side, THT/THR solder
GTIN (EAN)	4032248135905	connection, 3.50 mm, Number of poles: 4, 90°, Solder pin length (l):
Qty.	385 ST	1.5 mm, tinned, black, Tape

SL 3.50/90

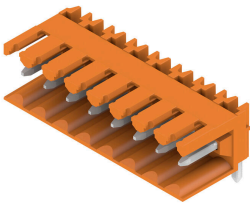

Pin headers for wave soldering in 3.50 mm pitch

- Plugging direction is parallel (90°), straight 180° or angled (135°) to the PCB
- Housing variant: screw flange (F)
- Packed in a cardboard box (BX)
- Pin header can be coded

General ordering data

Type	SL 3.50/04/90 3.2SN OR ...	Version
Order No.	1597230000	PCB plug-in connector, male header, open side, THT solder
GTIN (EAN)	4008190029838	connection, 3.50 mm, Number of poles: 4, 90°, Solder pin length (l):
Qty.	100 ST	3.2 mm, tinned, orange, Box

SL 3.50/180G

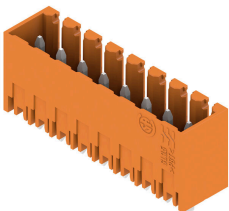

Pin headers for wave soldering in 3.50 mm pitch

- Plugging direction is parallel (90°), straight 180° or angled (135°) to the PCB
- Housing variant: screw flange (F)
- Packed in a cardboard box (BX)
- Pin header can be coded

General ordering data

Type	SL 3.50/04/180G 3.2SN O...	Version
Order No.	1604490000	PCB plug-in connector, male header, closed side, THT solder
GTIN (EAN)	4008190115852	connection, 3.50 mm, Number of poles: 4, 180°, Solder pin length (l):
Qty.	100 ST	3.2 mm, tinned, orange, Box
Type	SL 3.50/04/180G 4.5SN O...	Version
Order No.	1604640000	PCB plug-in connector, male header, closed side, THT solder
GTIN (EAN)	4008190120467	connection, 3.50 mm, Number of poles: 4, 180°, Solder pin length (l):
Qty.	100 ST	4.5 mm, tinned, orange, Box

BL 3.50/04/180LH SN OR BX

Weidmüller Interface GmbH & Co. KG
 Klingenbergstraße 26
 D-32758 Detmold
 Germany

Counterpart

www.weidmueller.com

SL 3.50/180

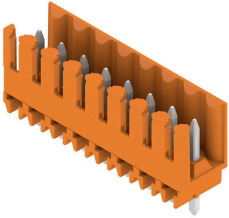

- Pin headers for wave soldering in 3.50 mm pitch
- Plugging direction is parallel (90°), straight 180° or angled (135°) to the PCB
 - Housing variant: screw flange (F)
 - Packed in a cardboard box (BX)
 - Pin header can be coded

General ordering data

Type	SL 3.50/04/180 3.2SN OR...	Version
Order No.	1604790000	PCB plug-in connector, male header, open side, THT solder
GTIN (EAN)	4008190127855	connection, 3.50 mm, Number of poles: 4, 180°, Solder pin length (l):
Qty.	100 ST	3.2 mm, tinned, orange, Box
Type	SL 3.50/04/180 4.5 SN O...	Version
Order No.	1604940000	PCB plug-in connector, male header, open side, THT solder
GTIN (EAN)	4008190029449	connection, 3.50 mm, Number of poles: 4, 180°, Solder pin length (l):
Qty.	100 ST	4.5 mm, tinned, orange, Box

SL 3.50/90G

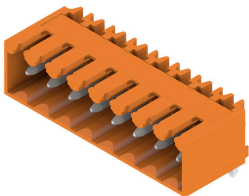

- Pin headers for wave soldering in 3.50 mm pitch
- Plugging direction is parallel (90°), straight 180° or angled (135°) to the PCB
 - Housing variant: screw flange (F)
 - Packed in a cardboard box (BX)
 - Pin header can be coded

General ordering data

Type	SL 3.50/04/90G 3.2SN OR...	Version
Order No.	1605090000	PCB plug-in connector, male header, closed side, THT solder
GTIN (EAN)	4008190054304	connection, 3.50 mm, Number of poles: 4, 90°, Solder pin length (l):
Qty.	100 ST	3.2 mm, tinned, orange, Box

SL 3.50/90

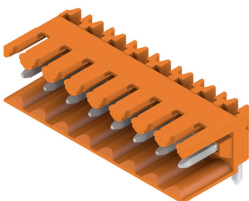

- Pin headers for wave soldering in 3.50 mm pitch
- Plugging direction is parallel (90°), straight 180° or angled (135°) to the PCB
 - Housing variant: screw flange (F)
 - Packed in a cardboard box (BX)
 - Pin header can be coded

BL 3.50/04/180LH SN OR BX

Weidmüller Interface GmbH & Co. KG
 Klingenbergstraße 26
 D-32758 Detmold
 Germany

Counterpart

www.weidmueller.com

General ordering data

Type	SL 3.50/04/90 3.2SN DKG...	Version
Order No.	1606820000	PCB plug-in connector, male header, open side, THT solder
GTIN (EAN)	4008190108311	connection, 3.50 mm, Number of poles: 4, 90°, Solder pin length (l):
Qty.	100 ST	3.2 mm, tinned, Signal green, Box

SL 3.50/90F

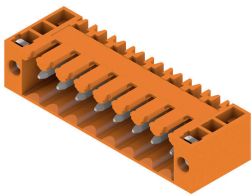

Pin headers for wave soldering in 3.50 mm pitch

- Plugging direction is parallel (90°), straight 180° or angled (135°) to the PCB
- Housing variant: screw flange (F)
- Packed in a cardboard box (BX)
- Pin header can be coded

General ordering data

Type	SL 3.50/04/90F 3.2SN OR...	Version
Order No.	1607060000	PCB plug-in connector, male header, Flange, THT solder connection,
GTIN (EAN)	4008190131661	3.50 mm, Number of poles: 4, 90°, Solder pin length (l): 3.2 mm,
Qty.	100 ST	tinned, orange, Box

SL 3.50/180G

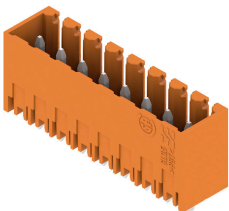

Pin headers for wave soldering in 3.50 mm pitch

- Plugging direction is parallel (90°), straight 180° or angled (135°) to the PCB
- Housing variant: screw flange (F)
- Packed in a cardboard box (BX)
- Pin header can be coded

General ordering data

Type	SL 3.50/04/180G 3.2SN D...	Version
Order No.	1607370000	PCB plug-in connector, male header, closed side, THT solder
GTIN (EAN)	4008190151362	connection, 3.50 mm, Number of poles: 4, 180°, Solder pin length (l):
Qty.	100 ST	3.2 mm, tinned, Signal green, Box

BL 3.50/04/180LH SN OR BX

Weidmüller Interface GmbH & Co. KG
 Klingenbergstraße 26
 D-32758 Detmold
 Germany

Counterpart

www.weidmueller.com

SL 3.50/180F

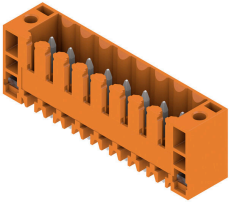

- Pin headers for wave soldering in 3.50 mm pitch
- Plugging direction is parallel (90°), straight 180° or angled (135°) to the PCB
 - Housing variant: screw flange (F)
 - Packed in a cardboard box (BX)
 - Pin header can be coded

General ordering data

Type	SL 3.50/04/180F 3.2SN O...	Version
Order No.	1607520000	PCB plug-in connector, male header, Flange, THT solder connection,
GTIN (EAN)	4008190039097	3.50 mm, Number of poles: 4, 180°, Solder pin length (l): 3.2 mm,
Qty.	100 ST	tinned, orange, Box

SL 3.50/90

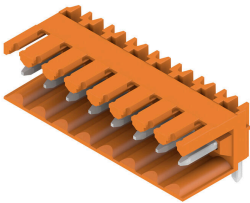

- Pin headers for wave soldering in 3.50 mm pitch
- Plugging direction is parallel (90°), straight 180° or angled (135°) to the PCB
 - Housing variant: screw flange (F)
 - Packed in a cardboard box (BX)
 - Pin header can be coded

General ordering data

Type	SL 3.50/04/90 4.5SN BK ...	Version
Order No.	1615310000	PCB plug-in connector, male header, open side, THT solder
GTIN (EAN)	4008190052539	connection, 3.50 mm, Number of poles: 4, 90°, Solder pin length (l):
Qty.	100 ST	4.5 mm, tinned, black, Box

SL 3.50/90G

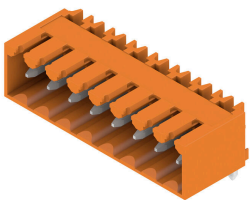

- Pin headers for wave soldering in 3.50 mm pitch
- Plugging direction is parallel (90°), straight 180° or angled (135°) to the PCB
 - Housing variant: screw flange (F)
 - Packed in a cardboard box (BX)
 - Pin header can be coded

General ordering data

Type	SL 3.50/04/90G4.5SN BK ...	Version
Order No.	1615430000	PCB plug-in connector, male header, closed side, THT solder
GTIN (EAN)	4008190054496	connection, 3.50 mm, Number of poles: 4, 90°, Solder pin length (l):
Qty.	100 ST	4.5 mm, tinned, black, Box

BL 3.50/04/180LH SN OR BX

Weidmüller Interface GmbH & Co. KG
 Klingenbergstraße 26
 D-32758 Detmold
 Germany

Counterpart

www.weidmueller.com

SL 3.50/90F

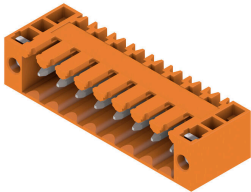

Pin headers for wave soldering in 3.50 mm pitch

- Plugging direction is parallel (90°), straight 180° or angled (135°) to the PCB
- Housing variant: screw flange (F)
- Packed in a cardboard box (BX)
- Pin header can be coded

General ordering data

Type	SL 3.50/04/90F 4.5 SN B...	Version
Order No.	1615550000	PCB plug-in connector, male header, Flange, THT solder connection,
GTIN (EAN)	4008190057220	3.50 mm, Number of poles: 4, 90°, Solder pin length (l): 4.5 mm,
Qty.	100 ST	tinned, black, Box

SL 3.50/180

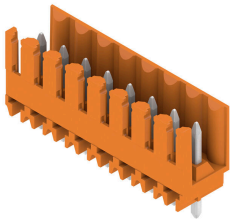

Pin headers for wave soldering in 3.50 mm pitch

- Plugging direction is parallel (90°), straight 180° or angled (135°) to the PCB
- Housing variant: screw flange (F)
- Packed in a cardboard box (BX)
- Pin header can be coded

General ordering data

Type	SL 3.50/04/180 4.5SN BK...	Version
Order No.	1615940000	PCB plug-in connector, male header, open side, THT solder
GTIN (EAN)	4008190064198	connection, 3.50 mm, Number of poles: 4, 180°, Solder pin length (l):
Qty.	100 ST	4.5 mm, tinned, black, Box

SL 3.50/180G

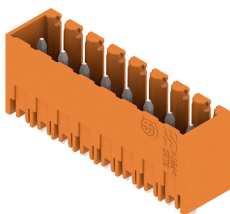

Pin headers for wave soldering in 3.50 mm pitch

- Plugging direction is parallel (90°), straight 180° or angled (135°) to the PCB
- Housing variant: screw flange (F)
- Packed in a cardboard box (BX)
- Pin header can be coded

General ordering data

Type	SL 3.50/04/180G 4.5SN B...	Version
Order No.	1616030000	PCB plug-in connector, male header, closed side, THT solder
GTIN (EAN)	4008190065492	connection, 3.50 mm, Number of poles: 4, 180°, Solder pin length (l):
Qty.	100 ST	4.5 mm, tinned, black, Box

BL 3.50/04/180LH SN OR BX

Weidmüller Interface GmbH & Co. KG
 Klingenbergstraße 26
 D-32758 Detmold
 Germany

www.weidmueller.com

Counterpart

SL 3.50/180F

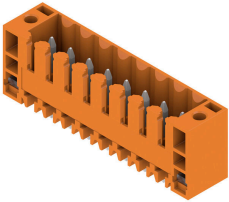

Pin headers for wave soldering in 3.50 mm pitch

- Plugging direction is parallel (90°), straight 180° or angled (135°) to the PCB
- Housing variant: screw flange (F)
- Packed in a cardboard box (BX)
- Pin header can be coded

General ordering data

Type	SL 3.50/04/180F 4.5 SN ...	Version
Order No.	1616160000	PCB plug-in connector, male header, Flange, THT solder connection,
GTIN (EAN)	4008190068301	3.50 mm, Number of poles: 4, 180°, Solder pin length (l): 4.5 mm,
Qty.	100 ST	tinned, black, Box

SL-SMT 3.5/90G Box



High-temperature-resistant male header, 3.50 mm pitch.

- Plugging direction parallel (90°), straight 180° or angled (135°) to PCB
- Housing variants: closed side (G), screw flange (F), solder flange (LF) or snap-on solder flange (RF)
- Optimised for the SMT process
- Pin length 3.2 mm universal for all soldering methods
- Pin length 1.5 mm optimised for reflow soldering methods
- Packed either in a box (BX) or tape-on-reel (RL)
- Male header can be coded

General ordering data

Type	SL-SMT 3.50/04/90G 3.2S...	Version
Order No.	1841650000	PCB plug-in connector, male header, closed side, THT/THR solder
GTIN (EAN)	4032248352807	connection, 3.50 mm, Number of poles: 4, 90°, Solder pin length (l):
Qty.	100 ST	3.2 mm, tinned, black, Box

SL-SMT 3.5/180G Box



High-temperature-resistant male header, 3.50 mm pitch.

- Plugging direction parallel (90°), straight 180° or angled (135°) to PCB
- Housing variants: closed side (G), screw flange (F), solder flange (LF) or snap-on solder flange (RF)
- Optimised for the SMT process
- Pin length 3.2 mm universal for all soldering methods
- Pin length 1.5 mm optimised for reflow soldering methods
- Packed either in a box (BX) or tape-on-reel (RL)
- Male header can be coded

BL 3.50/04/180LH SN OR BX

Weidmüller Interface GmbH & Co. KG
 Klingenbergstraße 26
 D-32758 Detmold
 Germany

Counterpart

www.weidmueller.com

General ordering data

Type	SL-SMT 3.50/04/180G 3.2...	Version
Order No.	1842340000	PCB plug-in connector, male header, closed side, THT/THR solder
GTIN (EAN)	4032248353682	connection, 3.50 mm, Number of poles: 4, 180°, Solder pin length (l):
Qty.	100 ST	3.2 mm, tinned, black, Box

SL-SMT 3.5/180G Tape

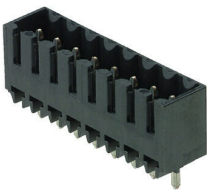

- High-temperature-resistant male header, 3.50 mm pitch.
- Plugging direction parallel (90°), straight 180° or angled (135°) to PCB
 - Housing variants: closed side (G), screw flange (F), solder flange (LF) or snap-on solder flange (RF)
 - Optimised for the SMT process
 - Pin length 3.2 mm universal for all soldering methods
 - Pin length 1.5 mm optimised for reflow soldering methods
 - Packed either in a box (BX) or tape-on-reel (RL)
 - Male header can be coded

General ordering data

Type	SL-SMT 3.50/04/180G 1.5...	Version
Order No.	1753004002	PCB plug-in connector, male header, closed side, THT/THR solder
GTIN (EAN)	4032248193219	connection, 3.50 mm, Number of poles: 4, 180°, Solder pin length (l):
Qty.	265 ST	1.5 mm, tinned, black, Tape

SL-SMT 3.5/90G Tape



- High-temperature-resistant male header, 3.50 mm pitch.
- Plugging direction parallel (90°), straight 180° or angled (135°) to PCB
 - Housing variants: closed side (G), screw flange (F), solder flange (LF) or snap-on solder flange (RF)
 - Optimised for the SMT process
 - Pin length 3.2 mm universal for all soldering methods
 - Pin length 1.5 mm optimised for reflow soldering methods
 - Packed either in a box (BX) or tape-on-reel (RL)
 - Male header can be coded

General ordering data

Type	SL-SMT 3.50/04/90G 1.5S...	Version
Order No.	1761564002	PCB plug-in connector, male header, closed side, THT/THR solder
GTIN (EAN)	4032248193349	connection, 3.50 mm, Number of poles: 4, 90°, Solder pin length (l):
Qty.	385 ST	1.5 mm, tinned, black, Tape

BL 3.50/04/180LH SN OR BX

Weidmüller Interface GmbH & Co. KG
 Klingenbergstraße 26
 D-32758 Detmold
 Germany

www.weidmueller.com

Counterpart

SL-THR 3.5/135F

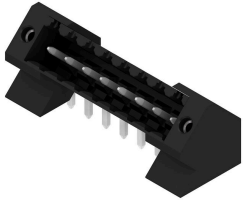

- High-temperature-resistant male header, 3.50 mm pitch.
- Plugging direction parallel (90°), straight 180° or angled (135°) to PCB
 - Housing variants: closed side (G), screw flange (F), solder flange (LF) or snap-on solder flange (RF)
 - Optimised for the SMT process
 - Pin length 3.2 mm universal for all soldering methods
 - Pin length 1.5 mm optimised for reflow soldering methods
 - Packed either in a box (BX) or tape-on-reel (RL)
 - Male header can be coded

General ordering data

Type	SL-SMT 3.50/04/135F 3.2...	Version
Order No.	1003530000	PCB plug-in connector, male header, Flange, THT/THR solder
GTIN (EAN)	4032248700165	connection, 3.50 mm, Number of poles: 4, 135°, Solder pin length (l):
Qty.	84 ST	3.2 mm, tinned, black, Box

SLD 3.50V/90F

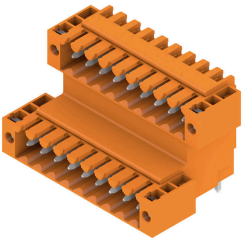

Double-level, staggered pin header for wave soldering at 3.50 mm pitch. They are available in closed and flanged versions. The male connectors provide space for labelling and can be coded.

General ordering data

Type	SLD 3.50 V/08/90F 3.2 S...	Version
Order No.	1642380000	PCB plug-in connector, male header, Flange, THT solder connection,
GTIN (EAN)	4008190280901	3.50 mm, Number of poles: 8, 90°, Solder pin length (l): 3.2 mm,
Qty.	50 ST	tinned, orange, Box

SL-SMT 3.5/180F Box

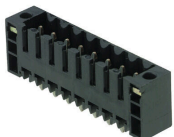

- High-temperature-resistant male header, 3.50 mm pitch.
- Plugging direction parallel (90°), straight 180° or angled (135°) to PCB
 - Housing variants: closed side (G), screw flange (F), solder flange (LF) or snap-on solder flange (RF)
 - Optimised for the SMT process
 - Pin length 3.2 mm universal for all soldering methods
 - Pin length 1.5 mm optimised for reflow soldering methods
 - Packed either in a box (BX) or tape-on-reel (RL)
 - Male header can be coded

BL 3.50/04/180LH SN OR BX

Weidmüller Interface GmbH & Co. KG
 Klingenbergstraße 26
 D-32758 Detmold
 Germany

Counterpart

www.weidmueller.com

General ordering data

Type	SL-SMT 3.50/04/180F 1.5...	Version
Order No.	1760982001	PCB plug-in connector, male header, Flange, THT/THR solder
GTIN (EAN)	4032248131556	connection, 3.50 mm, Number of poles: 4, 180°, Solder pin length (l):
Qty.	84 ST	1.5 mm, tinned, black, Box

SL-SMT 3.5/90F Box



- High-temperature-resistant male header, 3.50 mm pitch.
- Plugging direction parallel (90°), straight 180° or angled (135°) to PCB
 - Housing variants: closed side (G), screw flange (F), solder flange (LF) or snap-on solder flange (RF)
 - Optimised for the SMT process
 - Pin length 3.2 mm universal for all soldering methods
 - Pin length 1.5 mm optimised for reflow soldering methods
 - Packed either in a box (BX) or tape-on-reel (RL)
 - Male header can be coded

General ordering data

Type	SL-SMT 3.50/04/90F 1.5S...	Version
Order No.	1762022001	PCB plug-in connector, male header, Flange, THT/THR solder
GTIN (EAN)	4032248132430	connection, 3.50 mm, Number of poles: 4, 90°, Solder pin length (l):
Qty.	84 ST	1.5 mm, tinned, black, Box

SL-SMT 3.5/90LF Box

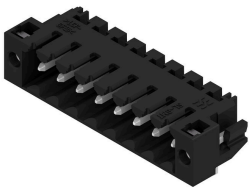

- High-temperature-resistant male header, 3.50 mm pitch.
- Plugging direction parallel (90°), straight 180° or angled (135°) to PCB
 - Housing variants: closed side (G), screw flange (F), solder flange (LF) or snap-on solder flange (RF)
 - Optimised for the SMT process
 - Pin length 3.2 mm universal for all soldering methods
 - Pin length 1.5 mm optimised for reflow soldering methods
 - Packed either in a box (BX) or tape-on-reel (RL)
 - Male header can be coded

General ordering data

Type	SL-SMT 3.50/04/90LF 1.5...	Version
Order No.	1804960000	PCB plug-in connector, male header, Solder flange, THT/THR solder
GTIN (EAN)	4032248268863	connection, 3.50 mm, Number of poles: 4, 90°, Solder pin length (l):
Qty.	84 ST	1.5 mm, tinned, black, Box

BL 3.50/04/180LH SN OR BX

Weidmüller Interface GmbH & Co. KG

Klingenbergstraße 26

D-32758 Detmold

Germany

www.weidmueller.com

Counterpart

SL-SMT 3.5/90LF Tape



High-temperature-resistant male header, 3.50 mm pitch.

- Plugging direction parallel (90°), straight 180° or angled (135°) to PCB
- Housing variants: closed side (G), screw flange (F), solder flange (LF) or snap-on solder flange (RF)
- Optimised for the SMT process
- Pin length 3.2 mm universal for all soldering methods
- Pin length 1.5 mm optimised for reflow soldering methods
- Packed either in a box (BX) or tape-on-reel (RL)
- Male header can be coded

General ordering data

Type	SL-SMT 3.50/04/90LF 1.5...	Version
Order No.	1805330000	PCB plug-in connector, male header, Solder flange, THT/THR solder
GTIN (EAN)	4032248269587	connection, 3.50 mm, Number of poles: 4, 90°, Solder pin length (l):
Qty.	385 ST	1.5 mm, tinned, black, Tape

SL-SMT 3.5/180LF Box

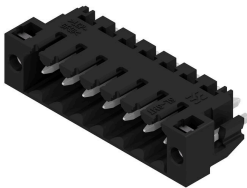

High-temperature-resistant male header, 3.50 mm pitch.

- Plugging direction parallel (90°), straight 180° or angled (135°) to PCB
- Housing variants: closed side (G), screw flange (F), solder flange (LF) or snap-on solder flange (RF)
- Optimised for the SMT process
- Pin length 3.2 mm universal for all soldering methods
- Pin length 1.5 mm optimised for reflow soldering methods
- Packed either in a box (BX) or tape-on-reel (RL)
- Male header can be coded

General ordering data

Type	SL-SMT 3.50/04/180LF 3....	Version
Order No.	1842560000	PCB plug-in connector, male header, Solder flange, THT/THR solder
GTIN (EAN)	4032248353927	connection, 3.50 mm, Number of poles: 4, 180°, Solder pin length (l):
Qty.	84 ST	3.2 mm, tinned, black, Box

SL-SMT 3.5/90F Box

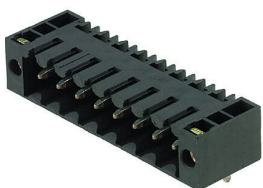

High-temperature-resistant male header, 3.50 mm pitch.

- Plugging direction parallel (90°), straight 180° or angled (135°) to PCB
- Housing variants: closed side (G), screw flange (F), solder flange (LF) or snap-on solder flange (RF)
- Optimised for the SMT process
- Pin length 3.2 mm universal for all soldering methods
- Pin length 1.5 mm optimised for reflow soldering methods
- Packed either in a box (BX) or tape-on-reel (RL)
- Male header can be coded

BL 3.50/04/180LH SN OR BX

Weidmüller Interface GmbH & Co. KG
 Klingenbergstraße 26
 D-32758 Detmold
 Germany

Counterpart

www.weidmueller.com

General ordering data

Type	SL-SMT 3.50/04/90F 3.2S...	Version
Order No.	1842100000	PCB plug-in connector, male header, Flange, THT/THR solder
GTIN (EAN)	4032248353453	connection, 3.50 mm, Number of poles: 4, 90°, Solder pin length (l):
Qty.	84 ST	3.2 mm, tinned, black, Box

SL-SMT 3.5/90LF Box

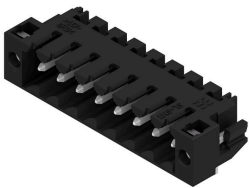

- High-temperature-resistant male header, 3.50 mm pitch.
- Plugging direction parallel (90°), straight 180° or angled (135°) to PCB
 - Housing variants: closed side (G), screw flange (F), solder flange (LF) or snap-on solder flange (RF)
 - Optimised for the SMT process
 - Pin length 3.2 mm universal for all soldering methods
 - Pin length 1.5 mm optimised for reflow soldering methods
 - Packed either in a box (BX) or tape-on-reel (RL)
 - Male header can be coded

General ordering data

Type	SL-SMT 3.50/04/90LF 3.2...	Version
Order No.	1841880000	PCB plug-in connector, male header, Solder flange, THT/THR solder
GTIN (EAN)	4032248353231	connection, 3.50 mm, Number of poles: 4, 90°, Solder pin length (l):
Qty.	84 ST	3.2 mm, tinned, black, Box

SL-SMT 3.5/180F Box



- High-temperature-resistant male header, 3.50 mm pitch.
- Plugging direction parallel (90°), straight 180° or angled (135°) to PCB
 - Housing variants: closed side (G), screw flange (F), solder flange (LF) or snap-on solder flange (RF)
 - Optimised for the SMT process
 - Pin length 3.2 mm universal for all soldering methods
 - Pin length 1.5 mm optimised for reflow soldering methods
 - Packed either in a box (BX) or tape-on-reel (RL)
 - Male header can be coded

General ordering data

Type	SL-SMT 3.50/04/180F 3.2...	Version
Order No.	1842790000	PCB plug-in connector, male header, Flange, THT/THR solder
GTIN (EAN)	4032248354153	connection, 3.50 mm, Number of poles: 4, 180°, Solder pin length (l):
Qty.	84 ST	3.2 mm, tinned, black, Box

BL 3.50/04/180LH SN OR BX

Weidmüller Interface GmbH & Co. KG
 Klingenbergstraße 26
 D-32758 Detmold
 Germany

www.weidmueller.com

Counterpart

SL-SMT 3.5/180LF Tape



- High-temperature-resistant male header, 3.50 mm pitch.
- Plugging direction parallel (90°), straight 180° or angled (135°) to PCB
 - Housing variants: closed side (G), screw flange (F), solder flange (LF) or snap-on solder flange (RF)
 - Optimised for the SMT process
 - Pin length 3.2 mm universal for all soldering methods
 - Pin length 1.5 mm optimised for reflow soldering methods
 - Packed either in a box (BX) or tape-on-reel (RL)
 - Male header can be coded

General ordering data

Type	SL-SMT 3.50/04/180LF 1....	Version
Order No.	1805240000	PCB plug-in connector, male header, Solder flange, THT/THR solder
GTIN (EAN)	4032248269518	connection, 3.50 mm, Number of poles: 4, 180°, Solder pin length (l):
Qty.	265 ST	1.5 mm, tinned, black, Tape

SL-SMT 3.5/180LF Box

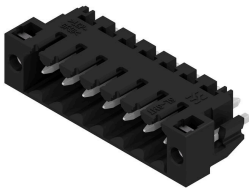

- High-temperature-resistant male header, 3.50 mm pitch.
- Plugging direction parallel (90°), straight 180° or angled (135°) to PCB
 - Housing variants: closed side (G), screw flange (F), solder flange (LF) or snap-on solder flange (RF)
 - Optimised for the SMT process
 - Pin length 3.2 mm universal for all soldering methods
 - Pin length 1.5 mm optimised for reflow soldering methods
 - Packed either in a box (BX) or tape-on-reel (RL)
 - Male header can be coded

General ordering data

Type	SL-SMT 3.50/04/180LF 1....	Version
Order No.	1804720000	PCB plug-in connector, male header, Solder flange, THT/THR solder
GTIN (EAN)	4032248268702	connection, 3.50 mm, Number of poles: 4, 180°, Solder pin length (l):
Qty.	84 ST	1.5 mm, tinned, black, Box