

RSS113024F**Weidmüller Interface GmbH & Co. KG**

Klingenbergstraße 26

D-32758 Detmold

Germany

www.weidmueller.com

Product image

Similar to illustration

Individual relays for TERMSERIES

- Electromechanical relays
- Different contact materials

General ordering data

Version	TERMSERIES, Relay, Number of contacts: 1, CO contact AgNi, Rated control voltage: 24 V DC, Continuous current: 6 A, Plug-in connection, Test button available: No
Order No.	1454430000
Type	RSS113024F
GTIN (EAN)	4050118261042
Qty.	18 items

Technical data

Approvals

Approvals



ROHS	Conform
UL File Number Search	UL Website
Certificate No. (cURus)	E223474

Dimensions and weights

Depth	15 mm	Depth (inches)	0.5906 inch
Height	28 mm	Height (inches)	1.1024 inch
Width	5 mm	Width (inches)	0.1968 inch
Net weight	5.1 g		

Temperatures

Storage temperature	-40 °C...85 °C	Ambient temperature	-40 °C...85 °C
Operating temperature		Humidity	5...85 % rel. humidity, no condensation

Environmental Product Compliance

RoHS Compliance Status	Compliant without exemption
REACH SVHC	No SVHC above 0.1 wt%

Rated data UL

Certificate No. (cURus)	E223474
-------------------------	---------

Control side

Rated control voltage	24 V DC	Rated current DC	7 mA
Power rating	170 mW	Coil resistance	3390 Ω ± 15 %
Status indicator	No		

Load side

Rated switching voltage	250 V AC	Max. switching frequency at rated load	0.1 Hz
Max. switching voltage, AC	250 V	Max. switching voltage, DC	250 V
Inrush current	20 A / 20 ms	AC switching capacity (resistive), max.	1500 VA
DC switching capacity (resistive), max.	144 W @ 24 V	Switch-on delay	<8 ms
Switch-off delay	<4 ms	Contact type	1 CO contact (AgNi)
Mechanical service life	10 x 10 ⁶ switching cycles	Min. switching power	1 mA @ 24 V, 10 mA @ 10 V, 100 mA @ 5 V

General data

Test button available	No	Mechanical switch position indicator	No
Colour	white	UL 94 flammability rating	V-0

RSS113024F

Weidmüller Interface GmbH & Co. KG
 Klingenbergstraße 26
 D-32758 Detmold
 Germany

www.weidmueller.com

Technical data

Insulation coordination

Clearance and creepage distances for control side - load side	≥ 6 mm	Dielectric strength for control side - load side	4 kVeff / 1 Min.
Dielectric strength of open contact	1 kVeff / 1 min	Protection degree	IP67

Further details of approvals / standards

Certificate No. (VDE)	40049192	Certificate No. (cURus)	E223474
-----------------------	----------	-------------------------	---------

Connection data

Wire connection method	Plug-in connection
------------------------	--------------------

Classifications

ETIM 8.0	EC001437	ETIM 9.0	EC001437
ETIM 10.0	EC001437	ECLASS 14.0	27-37-16-01
ECLASS 15.0	27-37-16-01		

Wiring diagram



View of Pins from below

Graph

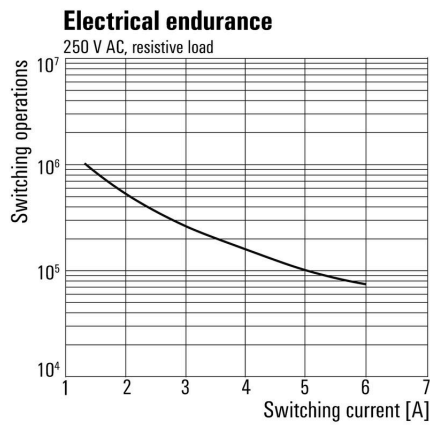

Electrical service life 230 V AC resistive load

Dimensional drawing

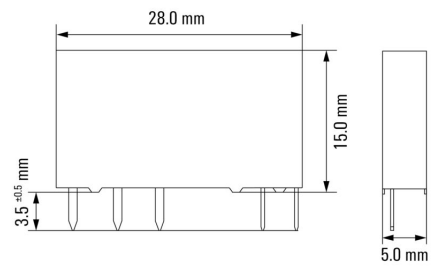

Miscellaneous

Type code electromechanical relay (TERMSERIES)



Type codes

RSS113024F

Weidmüller Interface GmbH & Co. KG

Klingenbergstraße 26

D-32758 Detmold

Germany

www.weidmueller.com

Accessories

Screw connection



TERMSERIES empty sockets with:

- 1 CO contact
- Unique multi-voltage input from 24 to 230 V UC
- Input voltages with coloured marking: DC: blue, UC: white
- Due to high-quality design and no sharp edges no risk of injuries during installation
- Partition plates for optical separation and reinforcement of insulation

General ordering data

Type	TRS 24VDC 1CO EMPTY	Version	
Order No.	1123240000	TERMSERIES, Relay socket, Number of contacts: 1, CO contact, Rated control voltage: 24 V DC \pm 20 %, Continuous current: 10 A, Screw connection	
GTIN (EAN)	4032248905485		
Qty.	10 ST		

Tension clamp connection

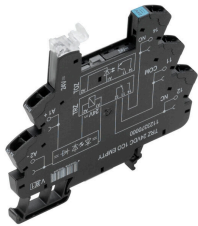

TERMSERIES empty sockets with:

- 1 CO contact
- Unique multi-voltage input from 24 to 230 V UC
- Input voltages with coloured marking: DC: blue, UC: white
- Due to high-quality design and no sharp edges no risk of injuries during installation
- Partition plates for optical separation and reinforcement of insulation

General ordering data

Type	TRZ 24VDC 1CO EMPTY	Version	
Order No.	1123370000	TERMSERIES, Relay socket, Number of contacts: 1, CO contact, Rated control voltage: 24 V DC \pm 20 %, Continuous current: 10 A, Tension-clamp connection	
GTIN (EAN)	4032248905324		
Qty.	10 ST		

PUSH IN connection

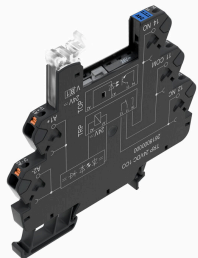

TERMSERIES empty sockets with:

- 1 CO contact
- Unique multi-voltage input from 24 to 230 V UC
- Input voltages with coloured marking: DC: blue, UC: white
- Due to high-quality design and no sharp edges no risk of injuries during installation
- Partition plates for optical separation and reinforcement of insulation

General ordering data

Type	TRP 24VDC 1CO EMPTY	Version	
Order No.	2618870000	TERMSERIES, Relay socket, Number of contacts: 1, CO contact, Rated control voltage: 24 V DC \pm 20 %, Continuous current: 10 A, PUSH IN	
GTIN (EAN)	4050118669961		
Qty.	10 ST		

RSS113024F

Weidmüller Interface GmbH & Co. KG
 Klingenbergstraße 26
 D-32758 Detmold
 Germany

www.weidmueller.com

Accessories

Screw connection



TERMSERIES empty sockets with:

- 1 CO contact
- Unique multi-voltage input from 24 to 230 V UC
- Input voltages with coloured marking: DC: blue, UC: white
- Due to high-quality design and no sharp edges no risk of injuries during installation
- Partition plates for optical separation and reinforcement of insulation

General ordering data

Type	TRS 24VUC 1CO EMPTY	Version	
Order No.	1123250000	TERMSERIES, Relay socket, Number of contacts: 1, CO contact, Rated control voltage: 24 V UC $\pm 10\%$, Continuous current: 10 A, Screw connection	
GTIN (EAN)	4032248905713		
Qty.	10 ST		

Tension clamp connection

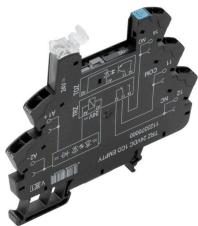

TERMSERIES empty sockets with:

- 1 CO contact
- Unique multi-voltage input from 24 to 230 V UC
- Input voltages with coloured marking: DC: blue, UC: white
- Due to high-quality design and no sharp edges no risk of injuries during installation
- Partition plates for optical separation and reinforcement of insulation

General ordering data

Type	TRZ 24VUC 1CO EMPTY	Version	
Order No.	1123380000	TERMSERIES, Relay socket, Number of contacts: 1, CO contact, Rated control voltage: 24 V UC $\pm 10\%$, Continuous current: 10 A, Tension-clamp connection	
GTIN (EAN)	4032248905195		
Qty.	10 ST		

PUSH IN connection

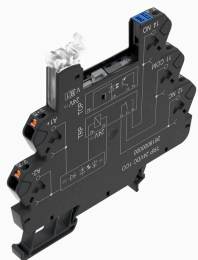

TERMSERIES empty sockets with:

- 1 CO contact
- Unique multi-voltage input from 24 to 230 V UC
- Input voltages with coloured marking: DC: blue, UC: white
- Due to high-quality design and no sharp edges no risk of injuries during installation
- Partition plates for optical separation and reinforcement of insulation

General ordering data

Type	TRP 24VUC 1CO EMPTY	Version	
Order No.	2618910000	TERMSERIES, Relay socket, Number of contacts: 1, CO contact, Rated control voltage: 24 V UC $\pm 10\%$, Continuous current: 10 A, PUSH IN	
GTIN (EAN)	4050118669923		
Qty.	10 ST		

RSS113024F

Weidmüller Interface GmbH & Co. KG
 Klingenbergstraße 26
 D-32758 Detmold
 Germany

www.weidmueller.com

Accessories

Screw connection



TERMSERIES empty sockets with:

- 1 CO contact
- Unique multi-voltage input from 24 to 230 V UC
- Input voltages with coloured marking: DC: blue, UC: white
- Due to high-quality design and no sharp edges no risk of injuries during installation
- Partition plates for optical separation and reinforcement of insulation

General ordering data

Type	TRS 48VUC 1CO EMPTY	Version	
Order No.	1123270000	TERMSERIES, Relay socket, Number of contacts: 1, CO contact, Rated control voltage: 48 V UC $\pm 10\%$, Continuous current: 10 A, Screw connection	
GTIN (EAN)	4032248905423		
Qty.	10 ST		

Tension clamp connection

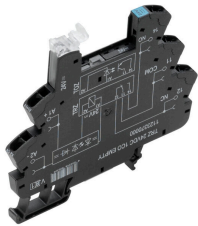

TERMSERIES empty sockets with:

- 1 CO contact
- Unique multi-voltage input from 24 to 230 V UC
- Input voltages with coloured marking: DC: blue, UC: white
- Due to high-quality design and no sharp edges no risk of injuries during installation
- Partition plates for optical separation and reinforcement of insulation

General ordering data

Type	TRZ 48VUC 1CO EMPTY	Version	
Order No.	1123390000	TERMSERIES, Relay socket, Number of contacts: 1, CO contact, Rated control voltage: 48 V UC $\pm 10\%$, Continuous current: 10 A, Tension-clamp connection	
GTIN (EAN)	4032248905331		
Qty.	10 ST		

PUSH IN connection

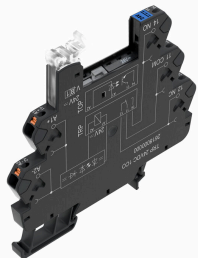

TERMSERIES empty sockets with:

- 1 CO contact
- Unique multi-voltage input from 24 to 230 V UC
- Input voltages with coloured marking: DC: blue, UC: white
- Due to high-quality design and no sharp edges no risk of injuries during installation
- Partition plates for optical separation and reinforcement of insulation

General ordering data

Type	TRP 48VUC 1CO EMPTY	Version	
Order No.	2618920000	TERMSERIES, Relay socket, Number of contacts: 1, CO contact, Rated control voltage: 48 V UC $\pm 10\%$, Continuous current: 10 A, PUSH IN	
GTIN (EAN)	4050118669916		
Qty.	10 ST		

RSS113024F

Weidmüller Interface GmbH & Co. KG

Klingenbergstraße 26

D-32758 Detmold

Germany

www.weidmueller.com

Accessories

Screw connection

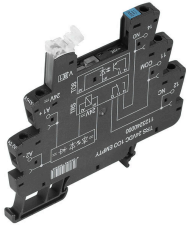

TERMSERIES empty sockets with:

- 1 CO contact
- Unique multi-voltage input from 24 to 230 V UC
- Input voltages with coloured marking: DC: blue, UC: white
- Due to high-quality design and no sharp edges no risk of injuries during installation
- Partition plates for optical separation and reinforcement of insulation

General ordering data

Type	TRS 24-230VUC 1CO EMPTY	Version	
Order No.	1123330000	TERMSERIES, Relay socket, Number of contacts: 1, CO contact, Rated control voltage: 24...230 V UC $\pm 10\%$, Continuous current: 10 A,	
GTIN (EAN)	4032248905614		
Qty.	10 ST	Screw connection	

Tension clamp connection

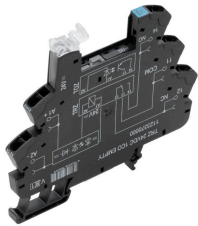

TERMSERIES empty sockets with:

- 1 CO contact
- Unique multi-voltage input from 24 to 230 V UC
- Input voltages with coloured marking: DC: blue, UC: white
- Due to high-quality design and no sharp edges no risk of injuries during installation
- Partition plates for optical separation and reinforcement of insulation

General ordering data

Type	TRZ 24-230VUC 1CO EMPTY	Version	
Order No.	1123450000	TERMSERIES, Relay socket, Number of contacts: 1, CO contact, Rated control voltage: 24...230 V UC $\pm 10\%$, Continuous current: 10 A,	
GTIN (EAN)	4032248905508		
Qty.	10 ST	Tension-clamp connection	

PUSH IN connection

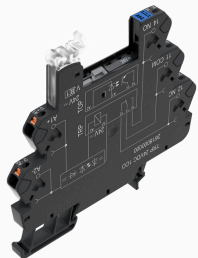

TERMSERIES empty sockets with:

- 1 CO contact
- Unique multi-voltage input from 24 to 230 V UC
- Input voltages with coloured marking: DC: blue, UC: white
- Due to high-quality design and no sharp edges no risk of injuries during installation
- Partition plates for optical separation and reinforcement of insulation

General ordering data

Type	TRP 24-230VUC 1CO EMPTY...	Version	
Order No.	2663030000	TERMSERIES, Relay socket, Number of contacts: 1, CO contact, Rated control voltage: 24...230 V UC $\pm 10\%$, Continuous current: 10 A,	
GTIN (EAN)	4050118698046		
Qty.	10 ST	PUSH IN	

RSS113024F

Weidmüller Interface GmbH & Co. KG
 Klingenbergstraße 26
 D-32758 Detmold
 Germany

www.weidmueller.com

Counterpart

Screw connection

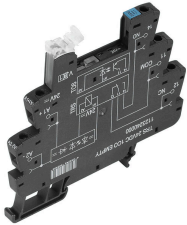

TERMSERIES empty sockets with:

- 1 CO contact
- Unique multi-voltage input from 24 to 230 V UC
- Input voltages with coloured marking: DC: blue, UC: white
- Due to high-quality design and no sharp edges no risk of injuries during installation
- Partition plates for optical separation and reinforcement of insulation

General ordering data

Type	TRS 24VDC 1CO EMPTY	Version
Order No.	1123240000	TERMSERIES, Relay socket, Number of contacts: 1, CO contact, Rated control voltage: 24 V DC $\pm 20\%$, Continuous current: 10 A, Screw connection
GTIN (EAN)	4032248905485	
Qty.	10 ST	
Type	TRS 24VUC 1CO EMPTY	Version
Order No.	1123250000	TERMSERIES, Relay socket, Number of contacts: 1, CO contact, Rated control voltage: 24 V UC $\pm 10\%$, Continuous current: 10 A, Screw connection
GTIN (EAN)	4032248905713	
Qty.	10 ST	
Type	TRS 48VUC 1CO EMPTY	Version
Order No.	1123270000	TERMSERIES, Relay socket, Number of contacts: 1, CO contact, Rated control voltage: 48 V UC $\pm 10\%$, Continuous current: 10 A, Screw connection
GTIN (EAN)	4032248905423	
Qty.	10 ST	
Type	TRS 24-230VUC 1CO EMPTY	Version
Order No.	1123330000	TERMSERIES, Relay socket, Number of contacts: 1, CO contact, Rated control voltage: 24...230 V UC $\pm 10\%$, Continuous current: 10 A, Screw connection
GTIN (EAN)	4032248905614	
Qty.	10 ST	

Tension clamp connection

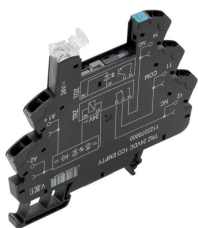

TERMSERIES empty sockets with:

- 1 CO contact
- Unique multi-voltage input from 24 to 230 V UC
- Input voltages with coloured marking: DC: blue, UC: white
- Due to high-quality design and no sharp edges no risk of injuries during installation
- Partition plates for optical separation and reinforcement of insulation

General ordering data

Type	TRZ 24VDC 1CO EMPTY	Version
Order No.	1123370000	TERMSERIES, Relay socket, Number of contacts: 1, CO contact, Rated control voltage: 24 V DC $\pm 20\%$, Continuous current: 10 A, Tension-clamp connection
GTIN (EAN)	4032248905324	
Qty.	10 ST	
Type	TRZ 24VUC 1CO EMPTY	Version
Order No.	1123380000	TERMSERIES, Relay socket, Number of contacts: 1, CO contact, Rated control voltage: 24 V UC $\pm 10\%$, Continuous current: 10 A, Tension-clamp connection
GTIN (EAN)	4032248905195	
Qty.	10 ST	

RSS113024F

Weidmüller Interface GmbH & Co. KG
 Klingenbergstraße 26
 D-32758 Detmold
 Germany

Counterpart

www.weidmueller.com

Type	TRZ 48VUC 1CO EMPTY	Version
Order No.	1123390000	TERMSERIES, Relay socket, Number of contacts: 1, CO contact, Rated
GTIN (EAN)	4032248905331	control voltage: 48 V UC $\pm 10\%$, Continuous current: 10 A, Tension-clamp connection
Qty.	10 ST	
Type	TRZ 24-230VUC 1CO EMPTY	Version
Order No.	1123450000	TERMSERIES, Relay socket, Number of contacts: 1, CO contact, Rated
GTIN (EAN)	4032248905508	control voltage: 24...230 V UC $\pm 10\%$, Continuous current: 10 A,
Qty.	10 ST	Tension-clamp connection

PUSH IN connection

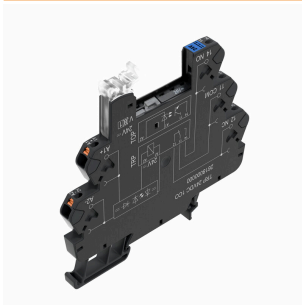

TERMSERIES empty sockets with:

- 1 CO contact
- Unique multi-voltage input from 24 to 230 V UC
- Input voltages with coloured marking: DC: blue, UC: white
- Due to high-quality design and no sharp edges no risk of injuries during installation
- Partition plates for optical separation and reinforcement of insulation

General ordering data

Type	TRP 24VDC 1CO EMPTY	Version
Order No.	2618870000	TERMSERIES, Relay socket, Number of contacts: 1, CO contact, Rated
GTIN (EAN)	4050118669961	control voltage: 24 V DC $\pm 20\%$, Continuous current: 10 A, PUSH IN
Qty.	10 ST	
Type	TRP 24VUC 1CO EMPTY	Version
Order No.	2618910000	TERMSERIES, Relay socket, Number of contacts: 1, CO contact, Rated
GTIN (EAN)	4050118669923	control voltage: 24 V UC $\pm 10\%$, Continuous current: 10 A, PUSH IN
Qty.	10 ST	
Type	TRP 48VUC 1CO EMPTY	Version
Order No.	2618920000	TERMSERIES, Relay socket, Number of contacts: 1, CO contact, Rated
GTIN (EAN)	4050118669916	control voltage: 48 V UC $\pm 10\%$, Continuous current: 10 A, PUSH IN
Qty.	10 ST	
Type	TRP T 24VDC 1CO M3 EMPTY	Version
Order No.	2639740000	TERMSERIES, Multifunction timing relay, Empty socket, Number
GTIN (EAN)	4050118797923	of contacts: 1, CO contact, Rated control voltage: 24 V DC $\pm 20\%$,
Qty.	10 ST	Continuous current: 10 A, PUSH IN

Counterpart

Screw connection

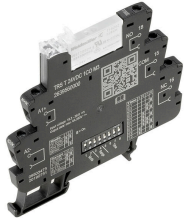

Timing relay for control signal adaptation with additional functions

Timing relays are used to coordinate fast switching processes in control systems, among other things. TERMSERIES TIMER timing relays have a on-delay, which allows for the delayed switch-on of machines, the cascaded start-up of system components or the delayed activation of consumers such as pumps or valves. They also have the One Shot and blinker functions. TERMSERIES TIMER timing relays in compact 6.4 mm terminal block format are available with either a screw connection or a PUSH IN wire connection. The timing functions and time ranges can be conveniently adjusted via the DIP switches on the side. The power supply and the respective switching status can be checked at a glance by means of the clearly visible duo LED on the ejection lever. International approvals in accordance with EN 61812 mean that they can be used anywhere in the world. TERMSERIES TIMER is compatible with the wide range of TERMSERIES accessories, thereby ensuring high levels of flexibility and simple integration into existing systems.

- Integration of additional timing functions in 6 mm TERMSERIES version
- Standard-compliant timing relays according to EN 61812
- Simple setting of timing functions and time ranges
- Integrated status LED (duo-LED in the ejection lever) for power supply and switching status

General ordering data

Type	TRS T 24VDC 1CO M3 EMPTY	Version	
Order No.	2639720000	TERMSERIES, Multifunction timing relay, Empty socket, Number	
GTIN (EAN)	4050118715576	of contacts: 1, CO contact, Rated control voltage: 24 V DC $\pm 20\%$,	
Qty.	10 ST	Continuous current: 10 A, Screw connection	

PUSH IN connection

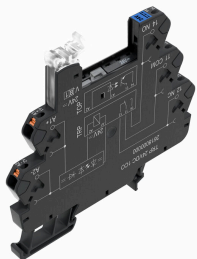

TERMSERIES empty sockets with:

- 1 CO contact
- Unique multi-voltage input from 24 to 230 V UC
- Input voltages with coloured marking: DC: blue, UC: white
- Due to high-quality design and no sharp edges no risk of injuries during installation
- Partition plates for optical separation and reinforcement of insulation

General ordering data

Type	TRP 24-230VUC 1CO EMPTY...	Version	
Order No.	2663030000	TERMSERIES, Relay socket, Number of contacts: 1, CO contact, Rated	
GTIN (EAN)	4050118698046	control voltage: 24...230 V UC $\pm 10\%$, Continuous current: 10 A,	
Qty.	10 ST	PUSH IN	

