

# XS1M12KP340D

inductive sensor XS1 M12, L61mm, brass, Sn2mm, 12..24VDC, M12



## Main

|                                    |                                                      |
|------------------------------------|------------------------------------------------------|
| Range of product                   | Telemecanique Inductive proximity sensors XS         |
| Series name                        | General purpose                                      |
| Sensor type                        | Inductive proximity sensor                           |
| Sensor name                        | XS1                                                  |
| Sensor design                      | Cylindrical M12                                      |
| Size                               | 61 mm                                                |
| Body type                          | Fixed                                                |
| Detector flush mounting acceptance | Flush mountable                                      |
| Material                           | Metal                                                |
| Type of output signal              | Discrete                                             |
| Wiring technique                   | 4-wire                                               |
| [Sn] nominal sensing distance      | 2 mm                                                 |
| Discrete output function           | 1 NO or 1 NC programmable                            |
| Output circuit type                | DC                                                   |
| Discrete output type               | PNP and NPN                                          |
| Electrical connection              | Male connector M12, 4 pins                           |
| [Us] rated supply voltage          | 12...24 V DC with reverse polarity protection        |
| Switching capacity in mA           | <= 200 mA with overload and short-circuit protection |
| IP degree of protection            | IP67 conforming to IEC 60529                         |

## Complementary

|                        |                              |
|------------------------|------------------------------|
| Thread type            | M12 x 1                      |
| Detection face         | Frontal                      |
| Front material         | PPS                          |
| Enclosure material     | Nickel plated brass          |
| Operating zone         | 0...1.6 mm                   |
| Differential travel    | 1...15% of Sr                |
| Status LED             | Output state: 1 LED (yellow) |
| Supply voltage limits  | 10...36 V DC                 |
| Switching frequency    | <= 5000 Hz                   |
| Maximum voltage drop   | <2.6 V (closed)              |
| Current consumption    | 0...10 mA no-load            |
| Maximum delay first up | 5 ms                         |
| Maximum delay response | 0.1 ms                       |
| Maximum delay recovery | 0.1 ms                       |
| Marking                | CE                           |
| Threaded length        | 42 mm                        |
| Length                 | 61 mm                        |
| Net weight             | 0.025 kg                     |

The information provided in this documentation contains general descriptions and/or technical characteristics of the performance of the products contained herein. This documentation is not intended as a substitute for and is not to be used for determining suitability or reliability of these products for specific user applications. It is the duty of any such user or integrator to perform the appropriate and complete risk analysis, evaluation and testing of the products with respect to the relevant specific application or use thereof. Neither TWSS Holding nor any of its affiliates or subsidiaries shall be responsible or liable for misuse of the information contained herein.

## Environment

|                                       |                                                                         |
|---------------------------------------|-------------------------------------------------------------------------|
| Product certifications                | CSA[RETURN]JUL                                                          |
| Ambient air temperature for operation | -25...70 °C                                                             |
| Ambient air temperature for storage   | -40...85 °C                                                             |
| Vibration resistance                  | 25 gn amplitude = +/- 2 mm (f = 10...55 Hz) conforming to IEC 60068-2-6 |
| Shock resistance                      | 50 gn for 11 ms conforming to IEC 60068-2-27                            |

## Packing Units

|                              |          |
|------------------------------|----------|
| Unit Type of Package 1       | PCE      |
| Number of Units in Package 1 | 1        |
| Package 1 Height             | 4.200 cm |
| Package 1 Width              | 6.500 cm |
| Package 1 Length             | 9.600 cm |
| Package 1 Weight             | 30.000 g |
| Unit Type of Package 2       | S02      |
| Number of Units in Package 2 | 44       |
| Package 2 Height             | 15 cm    |
| Package 2 Width              | 30 cm    |
| Package 2 Length             | 40 cm    |
| Package 2 Weight             | 1.648 kg |

## Offer Sustainability

|                                            |                                                                                                                                                                                                                                                                                                                                                                                   |
|--------------------------------------------|-----------------------------------------------------------------------------------------------------------------------------------------------------------------------------------------------------------------------------------------------------------------------------------------------------------------------------------------------------------------------------------|
| Sustainable offer status                   | Green Premium product                                                                                                                                                                                                                                                                                                                                                             |
| Circularity Profile                        | <a href="#">End of Life Information</a>                                                                                                                                                                                                                                                                                                                                           |
| California proposition 65                  | WARNING: This product can expose you to chemicals including: Diisononyl phthalate (DINP), which is known to the State of California to cause cancer, and Di-isodecyl phthalate (DIDP), which is known to the State of California to cause birth defects or other reproductive harm. For more information go to <a href="http://www.P65Warnings.ca.gov">www.P65Warnings.ca.gov</a> |
| For all Reach Rohs enquiries contact us at | <a href="mailto:sustainability@tesensors.com">sustainability@tesensors.com</a>                                                                                                                                                                                                                                                                                                    |

## Contractual warranty

|          |           |
|----------|-----------|
| Warranty | 18 months |
|----------|-----------|

Dimensions

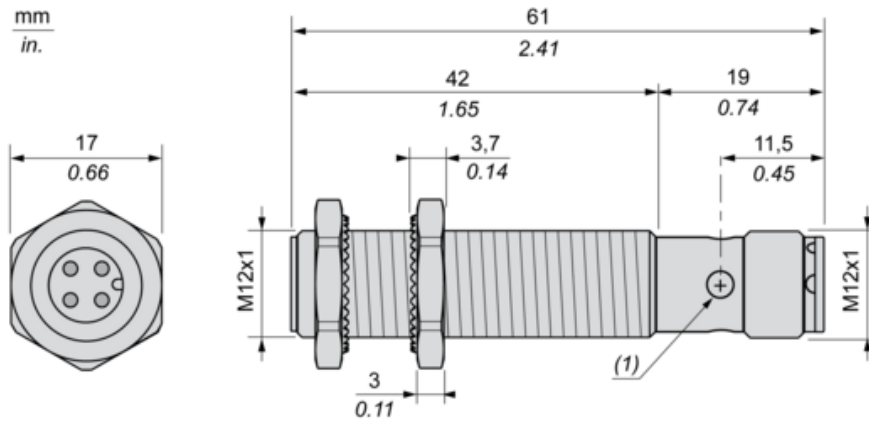

(1) : LED

---

Minimum Mounting Distances

---

Side by side

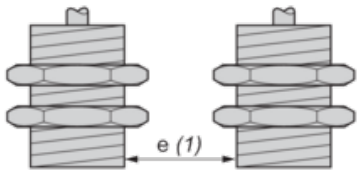

$e (1) \geq 4 \text{ mm}/0.16 \text{ in.}$

Face to face

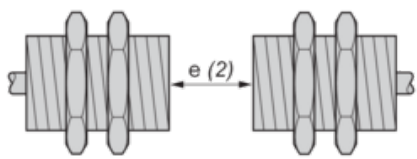

$e (2) \geq 24 \text{ mm}/0.94 \text{ in.}$

Facing a metal object

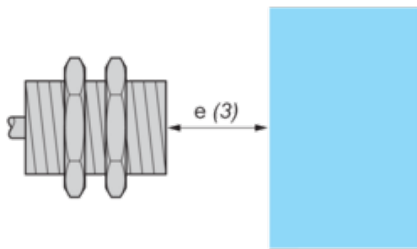

$e (3) \geq 6 \text{ mm}/0.24 \text{ in.}$

---

Wiring Schemes

---

M12 Connector

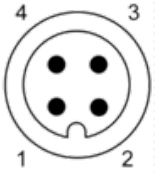

4-Wire DC, PNP/NPN, NO or NC output

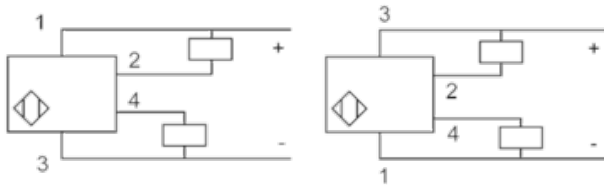

---

Performance Curves

---

Standard Steel Target : 12x12x1 mm

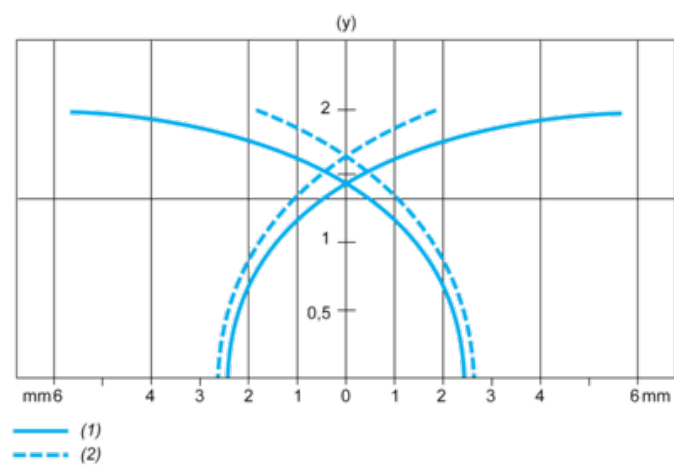

(1) Pick-up points

(2) Drop-out points (object approaching from the side)

(y) Sensing distance in mm